

# HECO-TOPIX®-plus

## European Technical Assessment ETA-19/0553

HECO-TOPIX®-plus (or HTP or HT-plus), HECO-TOPIX®-plus-T (or HTP-T or HT-plus-T) and HECO-TOPIX®-plus-CC screws (or HTP-CC or HT-plus-CC)  
Screws for use in timber constructions







ETA-Danmark A/S  
Göteborg Plads 1  
DK-2150 Nordhavn  
Tel. +45 72 24 59 00  
Fax +45 72 24 59 04  
Internet [www.etadanmark.dk](http://www.etadanmark.dk)

Authorised and notified according  
to Article 29 of the Regulation (EU)  
No 305/2011 of the European Par-  
liament and of the Council of 9  
March 2011

MEMBER OF EOTA



## European Technical Assessment ETA-19/0553 of 2021/06/16

### I General Part

**Technical Assessment Body issuing the ETA and designated according to Article 29 of the Regulation (EU) No 305/2011: ETA-Danmark A/S**

**Trade name of the construction product:**

HECO-TOPIX-plus (or HTP or HT-plus), HECO-TOPIX-plus-T (or HTP-T or HT-plus-T) and HECO-TOPIX-plus-CC (or HTP-CC or HT-plus-CC) screws

**Product family to which the above construction product belongs:**

Screws for use in timber constructions

**Manufacturer:**

HECO-Schrauben GmbH & Co. KG  
Dr.-Kurt-Steim-Straße 28  
DE-78713 Schramberg  
Internet [www.heco-schrauben.de](http://www.heco-schrauben.de)

**Manufacturing plant:**

HECO-Schrauben GmbH & Co. KG  
Dr.-Kurt-Steim-Straße 28  
DE-78713 Schramberg

S.C. HECO Schrauben S.R.L.  
Str. Laminoristilor Nr. 159  
RO-4051100 Campia Turzii

**This European Technical Assessment contains:**

81 pages including 6 annexes which form an integral part of the document

**This European Technical Assessment is issued in accordance with Regulation (EU) No 305/2011, on the basis of:**

European Assessment document (EAD) no. EAD 130118-01-0603 "Screws and threaded rods for use in timber constructions"

**This version replaces:**

The ETA with the same number issued on 2020-05-25

Translations of this European Technical Assessment in other languages shall fully correspond to the original issued document and should be identified as such.

Communication of this European Technical Assessment, including transmission by electronic means, shall be in full (excepted the confidential Annex(es) referred to above). However, partial reproduction may be made, with the written consent of the issuing Technical Assessment Body. Any partial reproduction has to be identified as such.

## II SPECIFIC PART OF THE EUROPEAN TECHNICAL ASSESSMENT

### 1 Technical description of product and intended use

#### Technical description of the product

HECO-TOPIX-plus with and without MagicClose (alternatively named HTP or HT-plus) and HECO-TOPIX-plus-T (alternatively named HTP-T or HT-plus-T) self-tapping screws are self-tapping screws made from special carbon steel or stainless steel. HECO-TOPIX-plus-CC (alternatively named HTP-CC or HT-plus-CC) self-tapping screws are self-tapping screws made from special carbon steel. The screws from special carbon steel are hardened. The screws made from stainless steel are not hardened.

The washers are made from carbon or stainless steel. The dimensions of the washers are given in Annex A.

#### Geometry and Material

The nominal diameter (outer thread diameter),  $d$ , of the self-tapping screws is not less than 3,5 mm and is not greater than 10,0 mm. The overall length of the screws,  $L$ , is not less than 20 mm and is not greater than 640 mm. Other dimensions are given in Annex A.

The ratio of inner thread diameter to outer thread diameter  $d_1/d$  ranges from 0,60 to 0,68.

The screws are threaded over a minimum length  $l_g$  of  $4 \cdot d$  (i.e.  $l_g \geq 4 \cdot d$ ).

The screws covered by this ETA have a bending angle,  $\alpha$ , of at least  $(45/d^{0,7} + 20)$  degrees.

### 2 Specification of the intended use in accordance with the applicable EAD

The screws are used for connections in load bearing timber structures between members of solid timber (softwood), glued laminated timber (softwood), cross-laminated timber (softwood), and laminated veneer lumber (softwood), similar glued members, wood-based panels or steel. The screws without MagicClose are also used for connections in load bearing members of solid timber (hardwood), glued laminated timber (hardwood) or laminated veneer lumber (hardwood), LVL (softwood) flanges of I-beams according to European Technical Assessments on the basis of ETAG 011.

Steel plates and wood-based panels except solid wood panels, laminated veneer lumber, CLT, particleboard and Oriented Strand Board, shall only be fixed on the side of the screw head.

The following wood-based panels may be used:

- Plywood according to EN 636 and EN 13986 or ETA or national provisions that apply at the installation site
- Oriented Strand Board, OSB according to EN 300 and EN 13986 or ETA or national provisions that apply at the installation site
- Particleboard according to EN 312 and EN 13986 or ETA or national provisions that apply at the installation site
- Fibreboard according to EN 622-2, EN 622-3 and EN 13986 or ETA (minimum density 650 kg/m<sup>3</sup>) or national provisions that apply at the installation site
- Cement-bonded particle boards according to EN 634-2 and EN 13986 or ETA or national provisions that apply at the installation site
- Solid-wood panels according to EN 13353 and EN 13986 or ETA or national provisions that apply at the installation site
- Engineered wood products according to ETA, provided that the ETA for the product provides provisions for the use of self-tapping screws and these provisions are applied

The screws are intended to be used in timber connections for which requirements for mechanical resistance and stability and safety in use in the sense of the Basic Works Requirements 1 and 4 of Regulation 305/2011 (EU) shall be fulfilled.

The design of the connections shall be based on the characteristic load-carrying capacities of the screws. The design capacities shall be derived from the characteristic capacities in accordance with Eurocode 5 or an appropriate national code.

The screws are intended for use for connections subject to static or quasi static loading.

The scope of the screws regarding resistance to corrosion shall be defined according to national provisions that apply at the installation site considering environmental conditions. The corrosion protection of the HECO screws is specified in Section 3.10.

The provisions made in this European Technical Assessment are based on an assumed intended working life of the screws of 50 years.

The indications given on the working life cannot be interpreted as a guarantee given by the producer or Assessment Body, but are to be regarded only as a means for choosing the right products in relation to the expected economically reasonable working life of the works.

**3 Performance of the product and references to the methods used for its assessment**

Characteristic	Assessment of characteristic	
<b>3.1 Mechanical resistance and stability*) (BWR1)</b>		
Tensile strength	Characteristic value $f_{\text{tens},k}$ :	
Screws made of carbon steel "HECO-TOPIX-plus" without MagicClose	d = 3,5 mm:	3,8 kN
	d = 4,0 mm:	4,7 kN
	d = 4,5 mm:	6,4 kN
	d = 5,0 mm:	7,9 kN
	d = 6,0 mm:	11,3 kN
	d = 8,0 mm:	20,0 kN
	d = 10,0 mm:	30,0 kN
Screws made of carbon steel "HECO-TOPIX-plus" with MagicClose	d = 3,5 mm:	3,4 kN
	d = 4,0 mm:	4,4 kN
	d = 4,5 mm:	5,6 kN
	d = 5,0 mm:	7,9 kN
	d = 6,0 mm:	11,3 kN
Screws made of carbon steel "HECO-TOPIX-plus-CC"	d = 6,0/6,5 mm:	10,0 kN
	d = 8,0/8,5 mm:	18,0 kN
Screws made of carbon steel "HECO-TOPIX-plus-T"	d = 8,0 mm:	20,0 kN
	d = 10,0 mm:	25,0 kN
Screws made of stainless steel "HECO-TOPIX-plus" without MagicClose	d = 3,5 mm:	2,9 kN
	d = 4,0 mm:	3,8 kN
	d = 4,5 mm:	4,8 kN
	d = 5,0 mm:	5,9 kN
	d = 6,0 mm:	7,5 kN
	d = 8,0 mm:	15,0 kN
	d = 10,0 mm:	22,0 kN
Screws made of stainless steel "HECO-TOPIX-plus" with MagicClose	d = 3,5 mm:	3,4 kN
	d = 4,0 mm:	4,4 kN
	d = 4,5 mm:	5,3 kN
	d = 5,0 mm:	7,4 kN
	d = 6,0 mm:	10,0 kN
Screws made of stainless steel "HECO-TOPIX-T"	d = 8,0 mm:	14,0 kN
	d = 10,0 mm:	22,0 kN
Insertion moment	Ratio of the characteristic torsional strength to the mean insertion moment: $f_{\text{tor},k} / R_{\text{tor,mean}} \geq 1,5$	
Torsional strength	Characteristic value $f_{\text{tor},k}$ :	
Screws made of carbon steel "HECO-TOPIX-plus" without MagicClose	d = 3,5 mm:	2,2 Nm
	d = 4,0 mm:	2,9 Nm
	d = 4,5 mm:	4,5 Nm
	d = 5,0 mm:	6,5 Nm
	d = 6,0 mm:	11,0 Nm
	d = 8,0 mm:	25,0 Nm
	d = 10,0 mm:	42,0 Nm

Characteristic	Assessment of characteristic	
Screws made of carbon steel “HECO-TOPIX-plus” with MagicClose	d = 3,5 mm:	2,1 Nm
	d = 4,0 mm:	2,9 Nm
	d = 4,5 mm:	4,5 Nm
	d = 5,0 mm:	6,2 Nm
	d = 6,0 mm:	11,0 Nm
Screws made of carbon steel “HECO-TOPIX-plus-CC”	d = 6,0/6,5 mm:	10,0 Nm
	d = 8,0/8,5 mm:	23,0 Nm
Screws made of carbon steel “HECO-TOPIX-plus-T”	d = 8,0 mm:	24,0 Nm
	d = 10,0 mm:	42,0 Nm
Screws made of stainless steel “HECO-TOPIX-plus” without MagicClose	d = 3,5 mm:	1,8 Nm
	d = 4,0 mm:	2,7 Nm
	d = 4,5 mm:	4,1 Nm
	d = 5,0 mm:	6,0 Nm
	d = 6,0 mm:	8,0 Nm
	d = 8,0 mm:	19,0 Nm
	d = 10,0 mm:	35,0 Nm
Screws made of stainless steel “HECO-TOPIX-plus” with MagicClose	d = 3,5 mm:	1,8 Nm
	d = 4,0 mm:	2,7 Nm
	d = 4,5 mm:	4,1 Nm
	d = 5,0 mm:	6,0 Nm
	d = 6,0 mm:	8,0 Nm
Screws made of stainless steel “HECO-TOPIX-plus-T”	d = 8,0 mm:	18,0 Nm
	d = 10,0 mm:	37,0 Nm
<b>3.2 Safety in case of fire (BWR2)</b>		
Reaction to fire	The screws are made from steel classified as Euroclass A1 in accordance with EN 13501-1 and Commission Delegated Regulation 2016/364.	
<b>3.7 Sustainable use of natural resources (BWR7)</b>	No Performance assessed	
<b>3.8 General aspects related to the performance of the product</b>	The screws have been assessed as having satisfactory durability and serviceability when used in timber structures using the timber species described in Eurocode 5 and subject to the conditions defined by service classes 1, 2 and 3.	

\*) See additional information in section 3.9 – 3.12.

### 3.9 Mechanical resistance and stability

The load-carrying capacities for HECO screws are applicable to the wood-based materials mentioned in paragraph 1 even though the term timber has been used in the following.

The characteristic lateral load-carrying capacities and the characteristic axial withdrawal capacities of HECO screws should be used for designs in accordance with Eurocode 5 or an appropriate national code.

The minimum penetration length of the threaded part of the screw  $l_{ef}$  shall be:

$$l_{ef} = \min = \begin{cases} \frac{4 \cdot d}{\sin \alpha} \\ 20 \cdot d \end{cases}$$

where

$d$  outer thread diameter

$\alpha$  angle between screw axis and grain direction.

For the fixing of rafters, point side penetration must be at least 40 mm,  $l_{ef} \geq 40$  mm.

The outer thread diameter of screws inserted in cross-laminated timber shall be at least 6 mm. The inner thread diameter  $d_1$  of the screws shall be greater than the maximal width of the gaps in the layer.

European Technical Assessments for structural members or wood-based panels must be considered where applicable.

#### Lateral load-carrying capacity

The characteristic lateral load-carrying capacity of HECO screws shall be calculated according to EN 1995-1-1:2008 (Eurocode 5) using the outer thread diameter  $d$  as the nominal diameter of the screw. The contribution from the rope effect may be considered.

The characteristic yield moment shall be assumed as:

HECO-TOPIX-plus, HECO-TOPIX-plus-CC and HECO-TOPIX-plus-T from carbon steel

$d = 3,5$ mm:	$M_{y,k} = 2,3$ Nm
$d = 4,0$ mm:	$M_{y,k} = 2,8$ Nm
$d = 4,5$ mm:	$M_{y,k} = 4,5$ Nm
$d = 5,0$ mm:	$M_{y,k} = 5,9$ Nm
$d = 6,0/6,5$ mm:	$M_{y,k} = 9,5$ Nm
$d = 8,0/8,5$ mm:	$M_{y,k} = 20,0$ Nm
$d = 10,0$ mm:	$M_{y,k} = 36,0$ Nm

HECO-TOPIX-plus screws without MagicClose from stainless steel

$d = 3,5$ mm:	$M_{y,k} = 1,9$ Nm
$d = 4,0$ mm:	$M_{y,k} = 2,8$ Nm
$d = 4,5$ mm:	$M_{y,k} = 3,4$ Nm
$d = 5,0$ mm:	$M_{y,k} = 4,4$ Nm
$d = 6,0$ mm:	$M_{y,k} = 7,1$ Nm
$d = 8,0$ mm:	$M_{y,k} = 17,0$ Nm
$d = 10,0$ mm:	$M_{y,k} = 30,0$ Nm

HECO-TOPIX-plus screws with MagicClose from stainless steel

$d = 3,5$ mm:	$M_{y,k} = 1,9$ Nm
$d = 4,0$ mm:	$M_{y,k} = 2,8$ Nm
$d = 4,5$ mm:	$M_{y,k} = 3,7$ Nm
$d = 5,0$ mm:	$M_{y,k} = 4,9$ Nm
$d = 6,0$ mm:	$M_{y,k} = 7,9$ Nm

HECO-TOPIX-plus-T from stainless steel

$d = 8,0$ mm:	$M_{y,k} = 15,0$ Nm
$d = 10,0$ mm:	$M_{y,k} = 27,0$ Nm

The embedding strength for the screws in timber members or in wood-based panels shall be taken from EN 1995-1-1 or from national provisions that apply at the installation site unless otherwise specified in the following.

The embedding strength for screws in non-pre-drilled holes in softwood or in ash, beech or oak hardwood arranged at an angle between screw axis and grain direction,  $0^\circ \leq \alpha \leq 90^\circ$  is:

$$f_{h,k} = \frac{0,082 \cdot \rho_k \cdot d^{-0,3}}{2,5 \cdot \cos^2 \alpha + \sin^2 \alpha} \quad [\text{N/mm}^2]$$

and accordingly for screws in pre-drilled holes:

$$f_{h,k} = \frac{0,082 \cdot \rho_k \cdot (1 - 0,01 \cdot d)}{2,5 \cdot \cos^2 \alpha + \sin^2 \alpha} \quad [\text{N/mm}^2]$$

Where

$\rho_k$  characteristic timber density [ $\text{kg/m}^3$ ], with a maximum characteristic density of  $590 \text{ kg/m}^3$  for ash, beech or oak hardwood;

$d$  outer thread diameter [mm];

$\alpha$  angle between screw axis and grain direction;

The embedding strength for screws arranged in the edge surface parallel to the plane of cross laminated timber, independent of the angle between screw axis and grain direction,  $0^\circ \leq \alpha \leq 90^\circ$ , shall be calculated from:

$$f_{h,k} = 20 \cdot d^{-0,5} \quad [\text{N/mm}^2]$$

unless otherwise specified in the technical specification (ETA or hEN) for the cross laminated timber.



Where

d outer thread diameter [mm]

The Equation is only valid for softwood layers. The provisions in the European Technical Assessment or in national provisions of the cross laminated timber apply.

The embedding strength for screws in the wide face of cross laminated timber should be assumed as for solid timber based on the characteristic density of the outer layer. Where applicable, the angle between force and grain direction of the outer layer shall be taken into account. The direction of the lateral force shall be perpendicular to the screw axis and parallel to the wide face of the cross laminated timber.

The embedding strength for screws in non-pre-drilled holes in softwood LVL arranged at an angle between screw axis and grain direction,  $0^\circ \leq \alpha \leq 90^\circ$  is:

$$f_{h,k} = \frac{0,082 \cdot \rho_k \cdot d^{-0,3}}{(2,5 \cdot \cos^2 \alpha + \sin^2 \alpha)(1,5 \cdot \cos^2 \beta + \sin^2 \beta)} \quad [\text{N/mm}^2]$$

and accordingly for screws in pre-drilled holes in softwood LVL:

$$f_{h,k} = \frac{0,082 \cdot \rho_k \cdot (1 - 0,01 \cdot d)}{(2,5 \cdot \cos^2 \alpha + \sin^2 \alpha)(1,5 \cdot \cos^2 \beta + \sin^2 \beta)} \quad [\text{N/mm}^2]$$

Where

$\rho_k$  characteristic timber density [ $\text{kg/m}^3$ ],  
 $\rho_k \leq 500 \text{ kg/m}^3$ ;  
d outer thread diameter [mm];  
 $\alpha$  angle between screw axis and grain direction;  
 $\beta$  angle between screw axis and the LVL's wide face ( $0^\circ \leq \beta \leq 90^\circ$ ).

The embedding strength for screws in pre-drilled or non-pre-drilled holes in Beech LVL according to EN 14374 or in GL75 according to ETA-14/0354 is:

$$f_{h,k} = \frac{0,082 \cdot \rho_k \cdot d^{-0,15}}{(2,5 \cdot \cos^2 \alpha + \sin^2 \alpha) \cdot k_\varepsilon \cdot k_\beta} \quad [\text{N/mm}^2]$$

Where

$\rho_k$  characteristic density [ $\text{kg/m}^3$ ];  
d outer thread diameter [mm];  
 $\alpha$  angle between screw axis and grain direction,  
 $0^\circ \leq \alpha \leq 90^\circ$ ;  
 $k_\varepsilon = (0,5 + 0,024 \cdot d) \cdot \sin^2 \varepsilon + \cos^2 \varepsilon$ ;  
 $\varepsilon$  angle between load and grain direction;  
 $0^\circ \leq \varepsilon \leq 90^\circ$ ;  
 $k_\beta = 1,2 \cdot \cos^2 \beta + \sin^2 \beta$ ;  
 $\beta$  angle between screw axis and wide face of LVL or GL75 member,  $0^\circ \leq \beta \leq 90^\circ$ .

### Axial withdrawal capacity

The characteristic axial withdrawal capacity of HECO screws at an angle of  $0^\circ < \alpha < 90^\circ$  to the grain in solid timber (softwood or hardwood species ash, beech and oak), glued laminated timber (softwood or hardwood species ash, beech and oak), cross laminated timber or laminated veneer lumber members, GL75 according to ETA-14/0354 or wood-based panels (only perpendicular to the panel plane) shall be calculated according to EN 1995-1-1 from:

$$F_{ax,\alpha,Rk} = \frac{n_{ef} \cdot k_{ax} \cdot f_{ax,k} \cdot d \cdot \ell_{ef} \cdot \left(\frac{\rho_k}{\rho_a}\right)^{0,8}}{k_\beta} \quad [\text{N}]$$

Where

$F_{ax,\alpha,Rk}$  characteristic withdrawal capacity of a screw group at an angle  $\alpha$  to the grain [N]

$n_{ef}$  Effective number of screws according to EN 1995-1-1:2008, clause 8.7.2 (8)

For inclined screws with an angle between shear plane and screw axis  $30^\circ \leq \alpha \leq 60^\circ$ :

$$n_{ef} = \max \{ n^{0,9}; 0,9 \cdot n \}$$

For inclined screws as fasteners in mechanically jointed beams or columns or for the fixing of thermal insulation material,  
 $n_{ef} = n$ .

n Number of screws acting together in a connection. If crossed pairs of screws are used in timber-to-timber connections, n is the number of crossed pairs of screws.

$k_{ax}$   $k_{ax} = 1,0$  for  $45^\circ \leq \alpha \leq 90^\circ$   
 $k_{ax} = 0,8$  for LVL flanges of I-beams for  $45^\circ \leq \alpha \leq 90^\circ$

$$k_{ax} = a + \frac{b \cdot \alpha}{45^\circ} \quad \text{for } 0^\circ \leq \alpha < 45^\circ$$

not valid for LVL flanges of I-beams

$$a = \begin{cases} 0,5 & \text{for LVL} \\ 0,3 & \text{for timber} \end{cases}$$

$$b = \begin{cases} 0,5 & \text{for LVL} \\ 0,7 & \text{for timber} \end{cases}$$

$k_\beta$   $k_\beta = 1,0$  for timber

$$k_\beta = 1,5 \cdot \cos^2 \beta + \sin^2 \beta \quad \text{for LVL}$$

$f_{ax,k}$  Characteristic withdrawal parameter for screws in solid or glued laminated timber, cross laminated timber and SWP members with maximum characteristic density of  $590 \text{ kg/m}^3$  and  $\rho_a = 350 \text{ kg/m}^3$ ;

$f_{ax,k} = 13,7 \text{ N/mm}^2$  for screws HECO-TOPIX-plus with  $3,5 \text{ mm} \leq d \leq 4,5 \text{ mm}$

$f_{ax,k} = 11,8 \text{ N/mm}^2$  for screws HECO-TOPIX-plus with  $5,0 \text{ mm} \leq d \leq 10,0 \text{ mm}$

$f_{ax,k} = 11,8 \text{ N/mm}^2$  for screws HECO-TOPIX-plus with MagicClose

$f_{ax,k} = 10,5 \text{ N/mm}^2$  for screws HECO-TOPIX-plus-T

$f_{ax,k} = 12,5 \text{ N/mm}^2$  for screws HECO-

TOPIX-plus-CC.

For screws in beech LVL or GL75 (ETA-14/0354) with  $590 \text{ kg/m}^3 \leq \rho_k \leq 750 \text{ kg/m}^3$  and  $\rho_a = 730 \text{ kg/m}^3$ :

$f_{ax,k} = 35,0 \text{ N/mm}^2$  for screws HECO-TOPIX-plus with  $5,0 \text{ mm} \leq d \leq 8,0 \text{ mm}$   
 $f_{ax,k} = 30,0 \text{ N/mm}^2$  for screws HECO-TOPIX-plus with  $d > 8,0 \text{ mm}$

For screws with  $4,0 \text{ mm} \leq d \leq 6,0 \text{ mm}$  in Particleboard and Oriented Strand Board with  $550 \text{ kg/m}^3 \leq \rho_k \leq 700 \text{ kg/m}^3$  and  $\rho_a = 600 \text{ kg/m}^3$ :  
 $f_{ax,k} = 10 \text{ N/mm}^2$

d	outer thread diameter [mm]
$\ell_{ef}$	penetration length of the threaded part according to EN 1995-1-1 [mm]
$\alpha$	angle between grain and screw axis
$\beta$	angle between screw axis and the LVL's wide face ( $0^\circ \leq \alpha \leq 90^\circ$ )
$\rho_k$	characteristic density [ $\text{kg/m}^3$ ]
$\rho_a$	associated density for $f_{ax,k}$ [ $\text{kg/m}^3$ ]

For screws penetrating more than one layer of cross laminated timber the different layers may be taken into account proportionally. In the lateral surfaces of the cross laminated timber the screws shall be fully inserted in one layer of cross-laminated timber.

### Head pull-through capacity

The characteristic head pull-through capacity of HECO self-tapping screws in solid timber (softwood or hardwood species ash, beech and oak), glued laminated timber (softwood or hardwood species ash, beech and oak), cross laminated timber, laminated veneer lumber members made of softwood or beech and wood-based panels shall be calculated according to EN 1995-1-1 from:

$$F_{ax,\alpha,Rk} = n_{ef} \cdot f_{head,k} \cdot d_h^2 \cdot \left( \frac{\rho_k}{350} \right)^{0,8} \quad [N]$$

where:

$F_{ax,\alpha,Rk}$	characteristic head pull-through capacity of the connection at an angle $\alpha \geq 30^\circ$ to the grain [N]
$n_{ef}$	effective number of screws according to EN 1995-1-1:2008, clause 8.7.2 (8) For inclined screws with an angle between shear plane and screw axis $30^\circ \leq \alpha \leq 60^\circ$ : $n_{ef} = \max \{ n^{0,9}; 0,9 \cdot n \}$ For inclined screws as fasteners in mechanically jointed beams or columns or for the fixing of thermal insulation material, $n_{ef} = n$ .
n	number of screws acting together in a connection. If crossed pairs of screws are used

in timber-to-timber connections, n is the number of crossed pairs of screws.

$f_{head,k}$	characteristic head pull-through parameter [ $\text{N/mm}^2$ ]
$d_h$	diameter of the screw head or the washer [mm]. Outer diameter of heads or washers $d_h > 32 \text{ mm}$ shall only be considered with a nominal diameter of 32 mm.
$\rho_k$	characteristic density of the timber member or of the wood-based panel [ $\text{kg/m}^3$ ], for wood-based panels $\rho_k \leq 380 \text{ kg/m}^3$ , for softwood LVL $\rho_k \leq 500 \text{ kg/m}^3$ , for ash, beech and oak $\rho_k \leq 590 \text{ kg/m}^3$ , for beech LVL or GL75 (ETA-14/0354) $\rho_k = 730 \text{ kg/m}^3$

The characteristic value of the head pull-through parameter for HECO screws in connection with softwood-based member and for wood-based panel like

- Plywood according to EN 636 and EN 13986
- Oriented Strand Board, OSB according to EN 300 and EN 13986
- Particleboard according to EN 312 and EN 13986
- Fibreboards according to EN 622-2, EN 622-3 and EN 13986
- Cement-bonded particle boards according to EN 634-2 and EN 13986,
- Solid-wood panels according to EN 13353 and EN 13986

with thicknesses of more than 20 mm and for  $\rho_a = 350 \text{ kg/m}^3$ :

$$f_{head,k} = 9,4 \text{ N/mm}^2 \quad d_h \leq 35 \text{ mm}$$

$$f_{head,k} = 14,0 \text{ N/mm}^2 \quad \text{for } d_h \leq 23 \text{ mm and head types flat countersunk head } 90^\circ, \text{ raised flange head or pan head}$$

Characteristic head pull-through parameter for HECO screws in connections with ash, beech and oak hardwood timber with a thickness of more than 20 mm and for  $\rho_a = 350 \text{ kg/m}^3$ :

$$f_{head,k} = 15 \text{ N/mm}^2 \quad \text{for } d_h > 20 \text{ mm and for washers;}$$

$$f_{head,k} = 20 \text{ N/mm}^2 \quad \text{for } d_h \leq 20 \text{ mm.}$$

Characteristic head pull-through parameter for HECO screws in connections with Beech LVL or GL75 (ETA-14/0354) with  $590 \text{ kg/m}^3 \leq \rho_k \leq 750 \text{ kg/m}^3$  for  $\rho_a = 350 \text{ kg/m}^3$  and with a thickness of at least 40 mm:  
 $f_{head,k} = 32,0 \text{ N/mm}^2 \quad \text{for } d_h \leq 35 \text{ mm.}$

Characteristic head pull-through parameter for HECO screws in connections with wood-based panels with a thickness  $12 \text{ mm} \leq t \leq 20 \text{ mm}$  for  $\rho_a = 350 \text{ kg/m}^3$ :

$$f_{\text{head,k}} = 8 \text{ N/mm}^2$$

The head diameter  $d_h$  shall be greater than  $1,8 \cdot d_s$ , where  $d_s$  is the smooth shank or the wire diameter. Otherwise the characteristic head pull-through capacity  $F_{\text{ax},\alpha,\text{Rk}} = 0$ .

For wood based panels with a thickness of less than 12 mm the characteristic head pull-through capacity for HECO screws shall be based on a characteristic value of the head pull-through parameter of  $8 \text{ N/mm}^2$ , and limited to 400 N complying with the minimum thickness of the wood based panels of  $1,2 \cdot d$ , with  $d$  as outer thread diameter and the values in Table 1.

Table 1: Minimum thickness of wood based panels

Wood based panel	Minimum thickness [mm]
Plywood	6
Fibreboards (hardboards and medium boards)	6
Oriented Strand Boards, OSB	8
Particleboards	8
Cement-bonded particle board	8
Solid wood Panels	12

For HECO-TOPIX-plus-T screws and fully threaded HECO-TOPIX-plus screws the withdrawal capacity of the thread in the timber member with the screw head may be taken into account instead of the head pull-through capacity:

$$F_{\text{ax},\alpha,\text{Rk}} = \max \left\{ \begin{array}{l} f_{\text{head,k}} \cdot d_h^2 \cdot \left( \frac{\rho_k}{350} \right)^{0,8} \\ n_{\text{ef}} \cdot k_{\text{ax}} \cdot f_{\text{ax,k}} \cdot l_{\text{ef,k}} \cdot d \cdot \left( \frac{\rho_k}{\rho_a} \right)^{0,8} \end{array} \right.$$

For HECO-TOPIX-plus-CC screws the withdrawal capacity of the thread in the timber member with the screw head shall be taken into account as:

$$F_{\text{ax},\alpha,\text{Rk}} = n_{\text{ef}} \cdot k_{\text{ax}} \cdot f_{\text{ax,k}} \cdot l_{\text{ef,k}} \cdot d \cdot \left( \frac{\rho_k}{\rho_a} \right)^{0,8}$$

where

- $d_h$  diameter of the screw head [mm],
- $\rho_k$  see axial withdrawal capacity,
- $k_{\text{ax}}$  see axial withdrawal capacity,
- $l_{\text{ef,k}}$  penetration length of the threaded part of the screw in the timber member with the screw head [mm],  $l_{\text{ef,k}} \geq 4 \cdot d$

In steel-to-timber connections the head pull-through capacity is not governing.

### Tensile strength

The characteristic tensile strength is given in Section 3.1.

For screws used in combination with steel plates, the tear-off capacity of the screw head including a washer shall be greater than the tensile capacity of the screw.

### Combined laterally and axially loaded screws

For connections subjected to a combination of axial and lateral load, the following expression should be satisfied:

$$\left( \frac{F_{\text{ax,Ed}}}{F_{\text{ax,Rd}}} \right)^2 + \left( \frac{F_{\text{la,Ed}}}{F_{\text{la,Rd}}} \right)^2 \leq 1$$

where

- $F_{\text{ax,Ed}}$  axial design load of the screw
- $F_{\text{la,Ed}}$  lateral design load of the screw
- $F_{\text{ax,Rd}}$  design load-carrying capacity of an axially loaded screw
- $F_{\text{la,Rd}}$  design load-carrying capacity of a laterally loaded screw

### Slip modulus

The axial slip modulus  $K_{\text{ser}}$  of the threaded part of a screw or threaded rod for the serviceability limit state should be taken independent of angle  $\alpha$  to the grain for solid timber, glued laminated timber, CLT or LVL as:

$$\begin{array}{l} K_{\text{ser}} = 25 \cdot d \cdot \ell_{\text{ef}} \text{ [N/mm]} \text{ for screws in softwood} \\ K_{\text{ser}} = 30 \cdot d \cdot \ell_{\text{ef}} \text{ [N/mm]} \text{ for screws in hardwood} \end{array}$$

Where

- $d$  outer thread diameter [mm]
- $\ell_{\text{ef}}$  penetration length in the timber member [mm]

### Spacing, end and edge distances

See annex B.

### Compression capacity

See annex C.

### Compression reinforcement

See annex D

### Tensile reinforcement

See annex E

### Thermal insulation material on top of rafters

See annex F

### 3.10 Aspects related to the performance of the product

Screws and washers made from carbon steel may have the coatings according to Table 2

Table 2 Coatings of the screws

Coating	Minimum thickness of the coating [μm]
electrogalvanized blue chromated	5
electrogalvanized yellow chromated	
electrogalvanized black chromated	
electrogalvanized olive chromated	
zinc-nickel coating, galvanic clad-ded, chromated	8
zinc flake basecoat	12

Steel no. 1.4567, 1.4578, 1.4462, 1.4539 and 1.4529 and 1.7033 are used for screws made from stainless steel.

Washers are made from steel no. 1.4305 or 1.4401. Contact corrosion shall be avoided.

### 3.11 General aspects related to the intended use of the product

The screws are manufactured in accordance with the provisions of the European Technical Assessment using the automated manufacturing process as identified during the inspection of the plant by the assessment body issuing the ETA and the notified body and laid down in the technical documentation.

The installation shall be carried out in accordance with Eurocode 5 or an appropriate national code unless otherwise is defined in the following. Instructions from the manufacturer should be considered for installation.

HECO self-tapping screws with an outer thread diameter of at least 6 mm may be used for the fixing of thermal insulation material on top of rafters or on wood-based members in vertical façades.

HECO-TOPIX-CC screws and fully threaded HECO-TOPIX-plus screws may be used for compression and tension reinforcing of timber structures perpendicular to the grain.

The angle between screw axis and grain direction is limited to  $15^\circ \leq \alpha \leq 90^\circ$  for connections in load bearing timber structures between members from softwood of solid timber, glued laminated timber, cross-laminated timber (CLT) and similar glued members for screws with

MagicClose. For screws with MagicClose in Laminated Veneer Lumber of softwood the angle  $\alpha$  is limited to  $60^\circ \leq \alpha \leq 90^\circ$ , where  $\alpha$  is the angle between the screw axis and the grain direction.

Screws made from carbon steel are either driven into the timber member made of softwood or hardwood without pre-drilling or in pre-drilled holes with a diameter according to Table 3. Screws made from stainless steel are either driven into timber members made of softwood with or without pre-drilling or into timber members made of hardwood in pre-drilled holes. The diameter of the pre-drilled holes according to Table 3 shall be considered.

The screws are driven into timber members made of ash, beech or oak with a maximum mean density of  $750 \text{ kg/m}^3$  and into timber members made of LVL made from beech according to EN 14374 or GL75 according to ETA-14/0354 with a maximum mean density of  $850 \text{ kg/m}^3$  in pre-drilled holes with a diameter according to Table 3.

Table 3: Recommended pre-drilling diameters

Nominal diameter d [mm]	Bore-hole diameter [mm]	
	Softwood	Hardwood
3,5	2,0	2,5
4,0	2,5	3,0
4,5	3,0	3,0
5,0	3,0	3,5
6,0	4,0	4,0
8,0	5,0	6,0
10,0	6,0	7,0

The screw holes in steel members shall be pre-drilled with an adequate diameter greater than the outer thread diameter.

The maximum penetration length of HECO-TOPIX-plus screws made from carbon steel in non-predrilled ash, beech, oak hardwood, beech LVL or GL75 (ETA-14/0354) is given in Table 4. If HECO-TOPIX-plus screws made from carbon steel are driven in two members, one consisting of ash, beech or oak hardwood or beech LVL and the other of softwood, the penetration length of the screw must not exceed the limit values of Table 5.

Table 4: Maximum penetration length without pre-drilling in hardwood

Nominal diameter d [mm]	Maximum penetration length [mm]
5,0	50
6,0	60
8,0	80
10,0	70

Table 5: Maximum penetration length without pre-drilling in hybrid connections

d [mm]	L <sub>c</sub> [mm]	L <sub>h</sub> [mm]	L <sub>t</sub> [mm]
6,0	150	40	40
8,0	160	60	40
10,0	200	70	40

with

- d nominal diameter
- L<sub>c</sub> maximum combined penetration length
- L<sub>h</sub> maximum penetration length in hardwood on the side of the screw head
- L<sub>t</sub> maximum penetration length in hardwood on the side of the screw tip

A minimum of two screws shall be used for connections in load bearing timber structures. This does not apply for special situations specified in National Annexes to EN 1995-1-1.

Only one screw may be used in structural connections when the minimum penetration length of the screw is  $20 \cdot d$ , the screw is only axially loaded and the angle between screw axis and grain direction is  $\alpha \geq 15^\circ$ . The load-bearing capacity of the screw shall be reduced by 50 %. If the screw is used as tensile or compressive reinforcement of timber structures perpendicular to the grain no reduction of the load-bearing capacity of the screw is required.

If screws with an outer thread diameter  $d \geq 8$  mm are driven into the wood-based member without pre-drilling, the structural solid or glued laminated timber, laminated veneer lumber and similar glued members shall be from spruce, pine, fir or hardwood considering the maximum penetration length according to Table 4.

In the case of fastening battens on thermal insulation material on top of rafters the screws shall be driven in the rafter through the battens and the thermal insulation material without pre-drilling in one sequence.

Countersunk head screws may be used with washers according to Annex A. After inserting the screw the washers shall touch the surface of the timber member completely. Screws made from carbon steel shall be used with washers made from carbon steel and screws made from stainless steel shall be used with washers made from stainless steel.

By fastening screws in wood-based members the head of the screws shall be flush with the surface of the wood based member. For pan head, raised countersunk head, flange head and hexagonal head screws the head part remains unconsidered

The screws may be used for connections in load bearing timber structures with structural members according to an associated ETA, if according to the ETA of the structural member a connection in load bearing timber structures with screws according to an ETA is allowed.

A minimum of two screws should be used for connections in load bearing timber structures.

The minimum penetration depth in structural members made of solid, glued or cross-laminated timber is  $4 \cdot d$ .

For structural members according to ETA's the terms of the ETA's must be considered.

For structural timber members, minimum spacing and distances for screws are given in EN 1995-1-1 (Eurocode 5) clause 8.3.1.2 and table 8.2 as for nails in predrilled or non-predrilled holes, respectively. Here, the outer thread diameter  $d$  must be considered. Alternatively minimum spacing and distances are given in Annex B.

## **4 Attestation and verification of constancy of performance (AVCP)**

### **4.1 AVCP system**

According to the decision 97/176/EC of the European Commission<sup>1</sup>, as amended, the system(s) of assessment and verification of constancy of performance (see Annex V to Regulation (EU) No 305/2011) is 3.

## **5 Technical details necessary for the implementation of the AVCP system, as foreseen in the applicable EAD**

Technical details necessary for the implementation of the AVCP system are laid down in the control plan deposited at ETA-Danmark prior to CE marking

Issued in Copenhagen on 2021-06-16 by

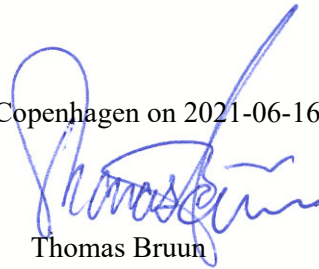

Thomas Bruun  
Managing Director, ETA-Danmark

## ANNEX A

### Drawings and thread design of HECO screws

#### Drawings

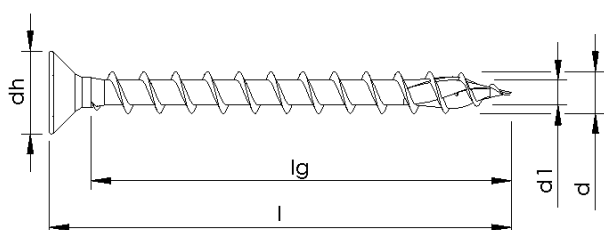

Full thread without variation, with milling ribs

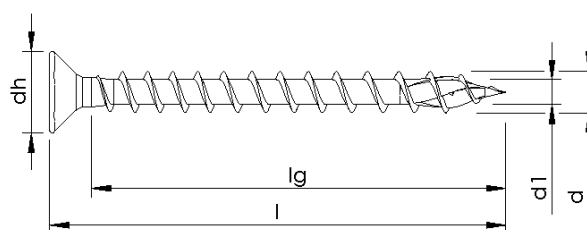

Full thread with variation, with milling ribs

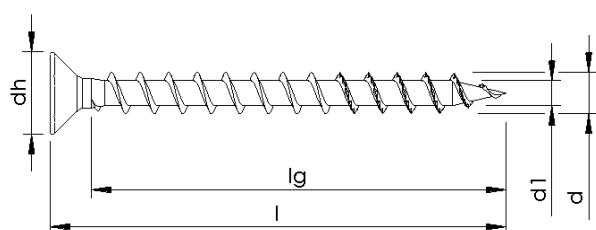

Full thread without variation, toothed tip

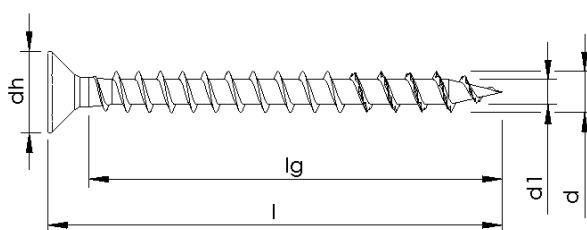

Full thread with variation, toothed tip

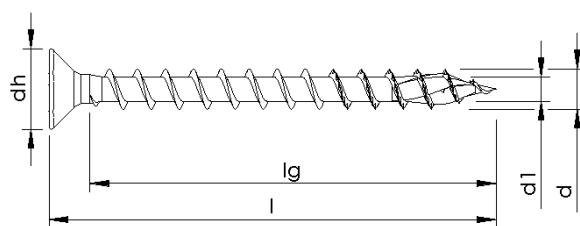

Full thread without variation, with milling ribs  
and toothed tip

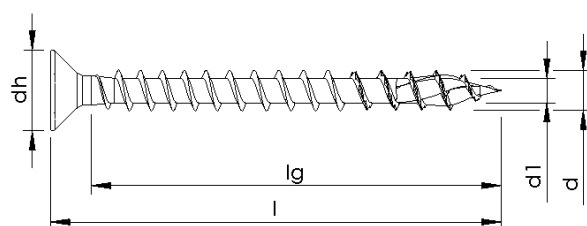

Full thread with variation, with milling ribs  
and toothed tip

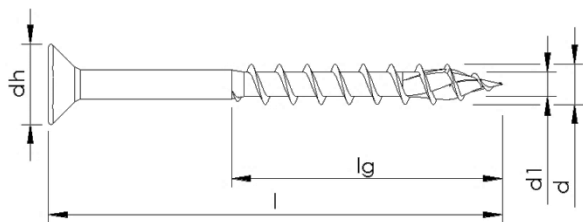

Part thread without variation, without shank ribs, with milling ribs

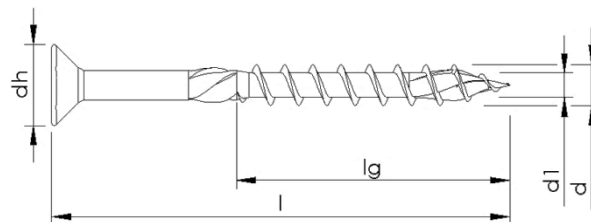

Part thread without variation, with shank ribs and milling ribs

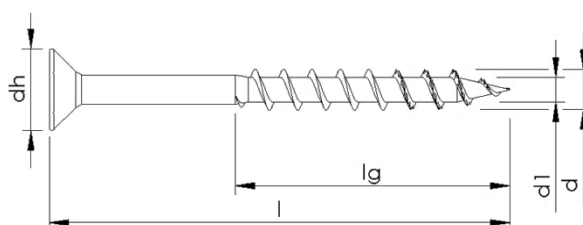

Part thread without variation, without shank ribs, with toothed tip

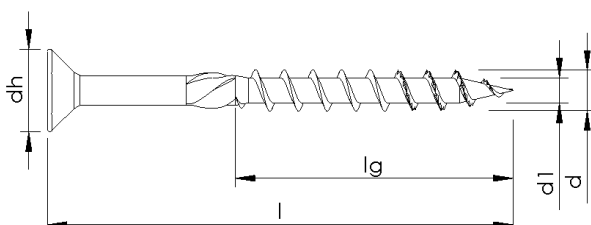

Part thread without variation, with shank ribs and toothed tip

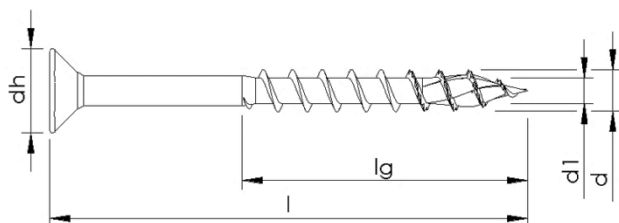

Part thread without variation, without shank ribs, with toothed tip and milling ribs

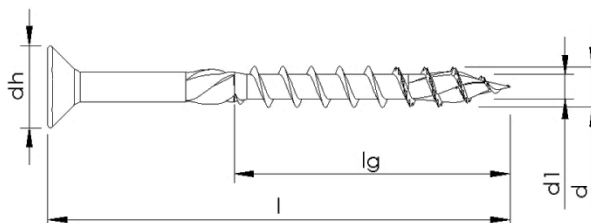

Part thread without variation, with shank ribs, with toothed tip and milling ribs



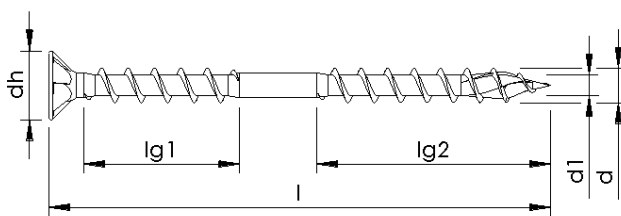

Secondary thread without variation, without shank ribs, with milling ribs

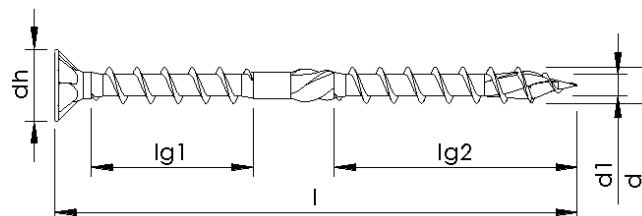

Secondary thread without variation, with shank ribs, with milling ribs

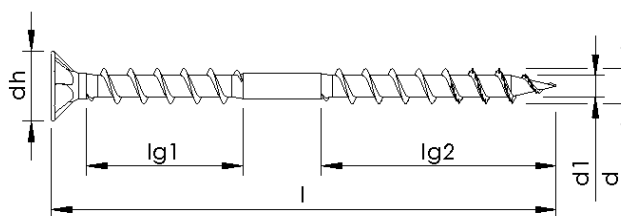

Secondary thread without variation, without shank ribs, with toothed tip

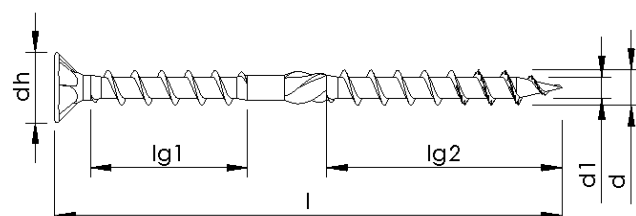

Secondary thread without variation, with shank ribs, with toothed tip

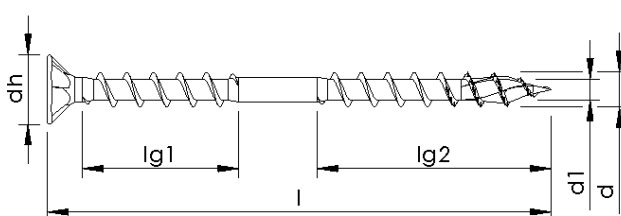

Secondary thread without variation, without shank ribs, with toothed tip and milling ribs

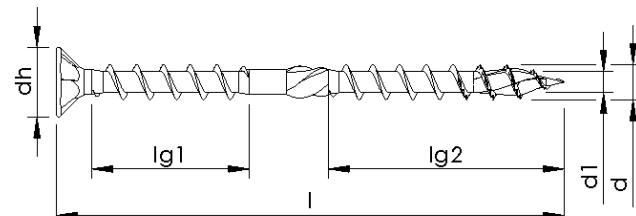

Secondary thread without variation, with shank ribs, with toothed tip and milling ribs

## Thread designs

All TOPIX-plus screws available as shown in figures I to V. Thread lengths can be tailored to suit specific customer requirements in the range from 4xd to lg max

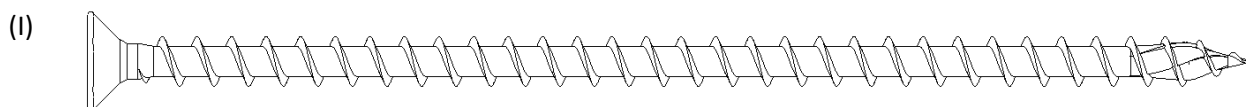

Full thread (FT)

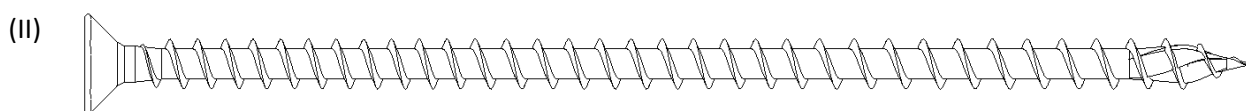

Full thread with thread variation (VFT)

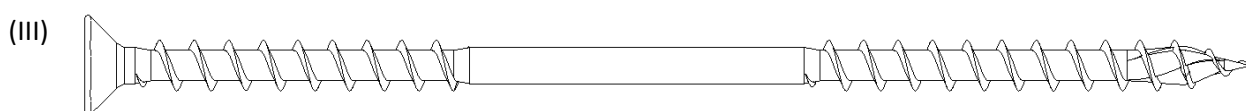

With secondary thread (ST,CC)

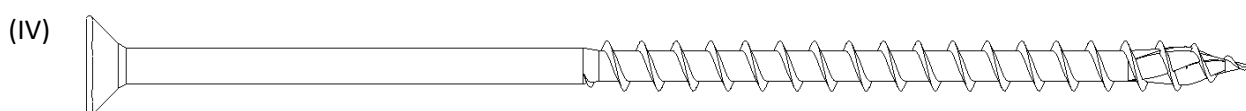

Part thread (PT)

The length and the thread of the screw can be increased optionally up to the maximum thread or screws length, for fixations of insulation or insulation boards, covered with various materials like metal, timber or wood-based panels, fastened at a distance to the timber substructure or in case of fastening in dowels. The respective lengths are shown in the following annexes.

## Tolerances of dimension

Dimension	Range		Tolerance in relation to the relevant dimension
	Above	Up to and including	
<b>l, l<sub>g</sub><sup>a</sup></b>	10 mm	18 mm	± 1,5 mm
	18 mm	30 mm	± 1,7 mm
	30 mm	50 mm	± 2,0 mm
	50 mm	80 mm	± 2,3 mm
	80 mm	120 mm	± 2,7 mm
	120 mm	180 mm	± 3,2 mm
	180 mm	250 mm	± 3,6 mm
	250 mm	315 mm	± 4,1 mm
	315 mm	400 mm	± 4,5 mm
	400 mm	500 mm	± 4,9 mm
	500 mm	630 mm	± 5,5 mm
	630 mm	800 mm	± 6,3 mm
	800 mm	1.000 mm	± 7,0 mm
	1.000 mm	1.250 mm	± 8,3 mm
1.250 mm	-	± 9,3 mm	
<b>d<sub>1</sub>, d, d<sub>s</sub></b>	2,4 mm	6 mm	± 0,3 mm
	6 mm	24 mm	± 5%
<b>d<sub>h</sub></b>	-	8 mm	± 0,5 mm
	8 mm	12 mm	± 0,6 mm
	12 mm	-	± 5%
<b>p</b>	all		± 10%
<sup>a</sup> Larger tolerances may be specified in the ETA. They shall be used in the calculation by specifying the minimum length l or thread length l <sub>g</sub> .			

## Head types for d = 3.5 mm, all materials

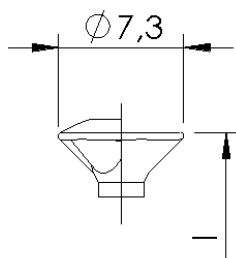

Flat countersunk head 90° with and without raised head, with and without milling pockets

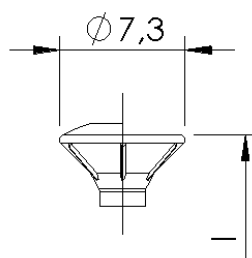

Flat countersunk head 90° with and without raised head, with and without milling ribs

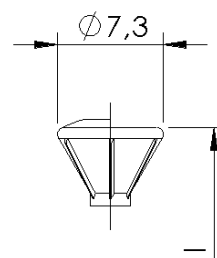

Flat countersunk head 60° / 75°, with and without raised head, with and without milling ribs

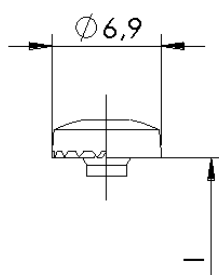

Pan head with and without milling ribs underneath the head

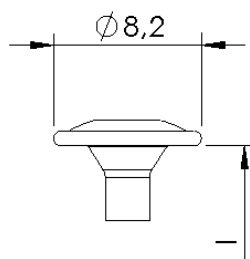

Raised flange head

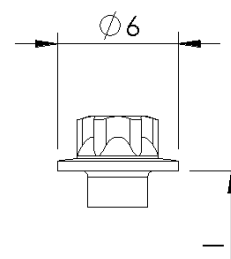

External hexagon head with washer

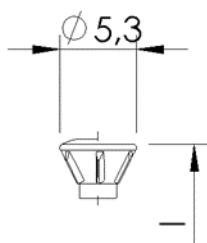

Flat countersunk head 60° / 75°, with and without raised head, with and without milling ribs

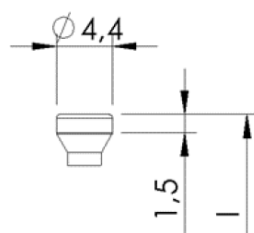

Cylindrical countersunk head

## Thread types for $d = 3.5$ mm, steel

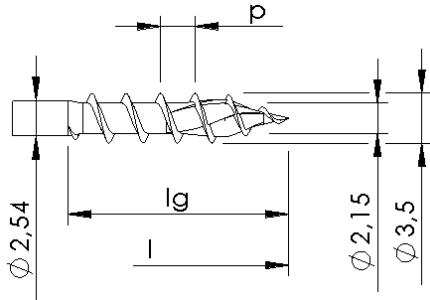

With and without variation,  
with milling ribs

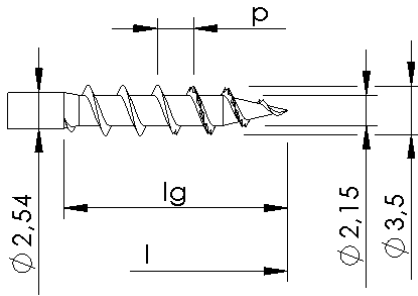

With and without variation,  
with toothed tip

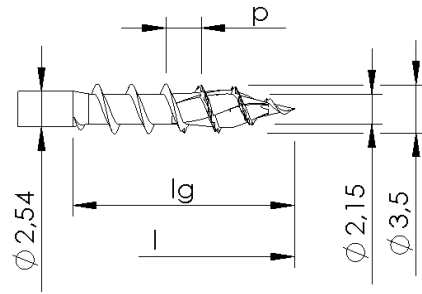

With and without variation,  
with toothed tip and milling ribs

## Shank ribs for $d = 3.5$ mm, steel

Shank ribs can be processed as shank rings too. These may be arranged in the same way over the complete shaft or processed in a part of it. All dimensions in mm.

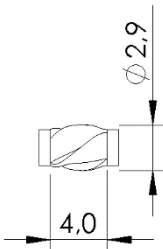

## Lengths for d = 3.5 mm, steel

Screws can be processed as full or part threaded, with or without thread variation, without thread in the middle or without thread underneath the head or a combination of both is possible (see “Thread designs”). The thread lengths can be tailored and produced to specific customer requirements in the range of lg min and lg max. All dimensions in mm.

### without Magic Close

l	lg
16	14
...	...
50	46

### with Magic Close

l	lg
16	14
...	...
60	57

## Thread types for d = 3.5 mm, stainless steel

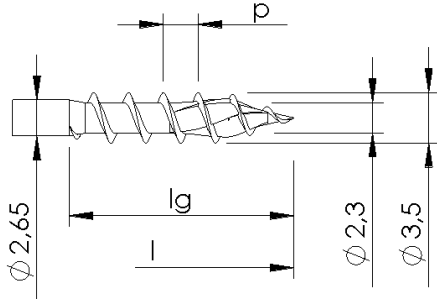

With and without thread variation,  
with milling ribs

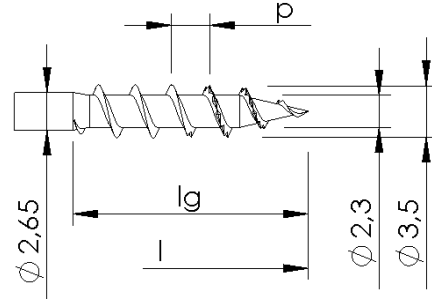

With and without thread variation,  
with toothed tip

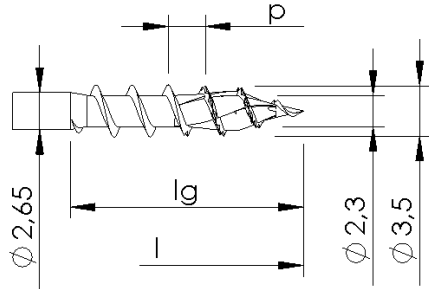

With and without thread variation,  
with milling ribs and toothed tip

## Shank ribs for d = 3.5 mm, stainless steel

Shank ribs can be processed as shank rings too. These may be arranged in the same way over the complete shaft or processed in a part of it. All dimensions in mm.

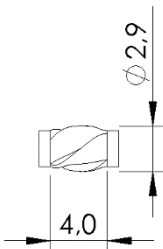

## Lengths for d = 3.5 mm, stainless steel

Screws can be processed as full or part threaded, with or without thread variation, without thread in the middle or without thread underneath the head or a combination of both is possible (see “Thread designs”). The thread lengths can be tailored and produced to specific customer requirements in the range of lg min and lg max. All dimensions in mm.

### without Magic Close

l	lg
16	14
...	...
50	46

### with Magic Close

l	lg
16	14
...	...
60	57



## Head types for d = 4.0 mm, all materials

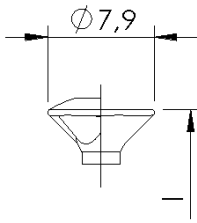

Flat countersunk head 90° with and without raised head, with and without milling pockets

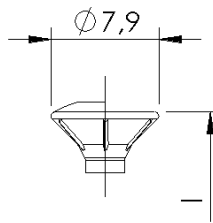

Flat countersunk head 90° with and without raised head, with and without milling ribs

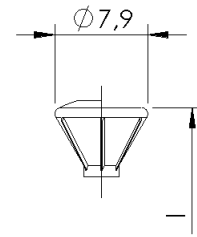

Flat countersunk head 60° /75°, with and without raised head, with and without milling ribs

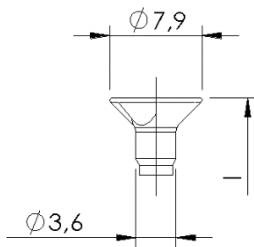

Flat countersunk head 90° with centre drilled hole, with and without milling pockets

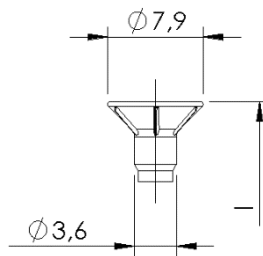

Flat countersunk head 90° with centre drilled hole, with and without milling ribs

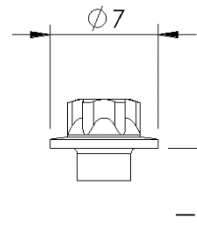

External hexagon head with and without washer

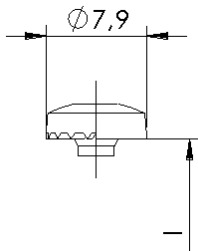

Pan head with and without milling ribs underneath the head

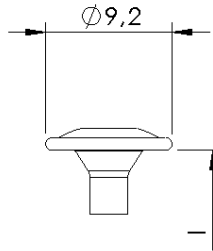

Raised flange head

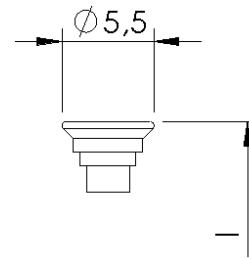

Multi-staged head

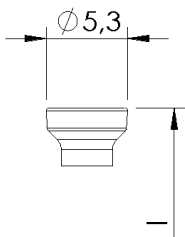

Cylindrical countersunk head

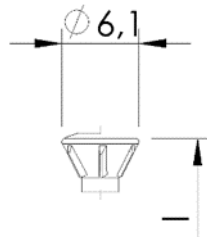

Flat countersunk head 60° /75°, with and without raised head, with and without milling ribs

## Thread types for d = 4.0 mm, steel

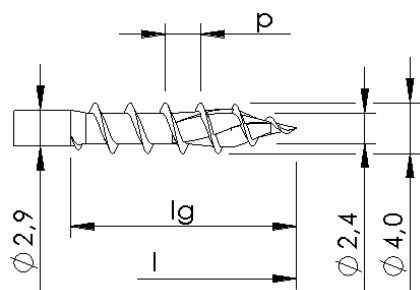

With and without thread variation,  
with milling ribs

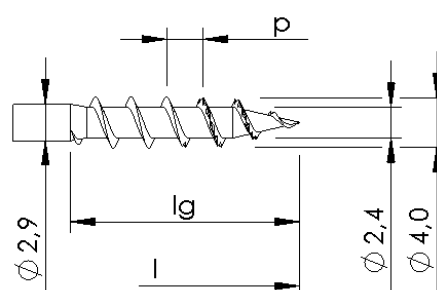

With and without thread variation,  
with toothed tip

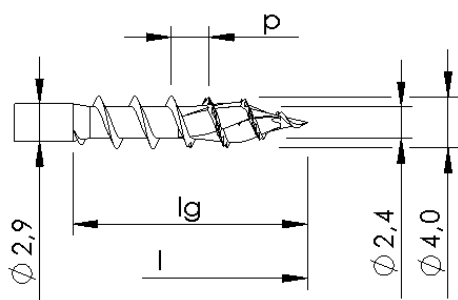

With and without thread variation,  
with toothed tip and milling ribs

## Shank ribs for d = 4.0 mm, steel

Shank ribs can be processed as shank rings too. These may be arranged in the same way over the complete shaft or processed in a part of it. All dimensions in mm.

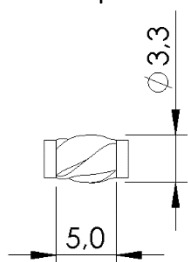

## Lengths for d = 4.0 mm, steel

Screws can be processed as full or part threaded, with or without thread variation, without thread in the middle or without thread underneath the head or a combination of both is possible (see “Thread designs”). The thread lengths can be tailored and produced to specific customer requirements in the range of lg min and lg max. All dimensions in mm.

### without Magic Close

l	lg
20	15
...	...
70	54

### with Magic Close

l	lg
20	15
...	...
70	66

## Thread types for d = 4.0 mm, stainless steel

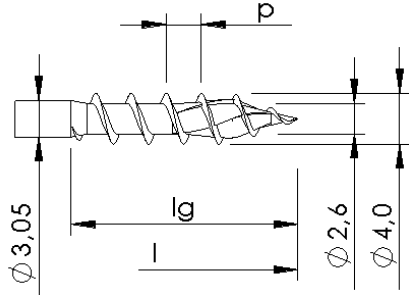

With and without thread variation,  
with milling ribs

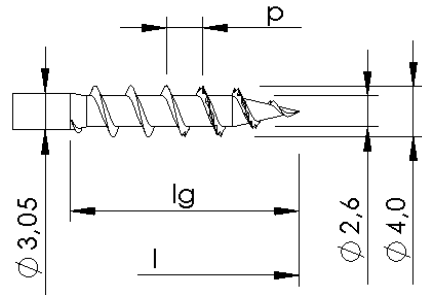

With and without thread variation,  
with toothed tip

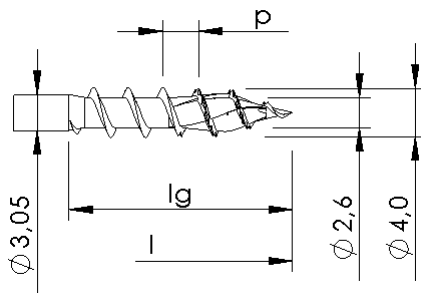

With and without thread variation,  
with toothed tip and milling ribs

## Shank ribs for d = 4.0 mm, stainless steel

Shank ribs can be processed as shank rings too. These may be arranged in the same way over the complete shaft or processed in a part of it. All dimensions in mm.

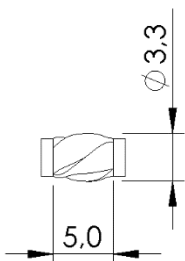

## Lengths for d = 4.0 mm, stainless steel

Screws can be processed as full or part threaded, with or without thread variation, without thread in the middle or without thread underneath the head or a combination of both is possible (see “Thread designs”). The thread lengths can be tailored and produced to specific customer requirements in the range of lg min and lg max. All dimensions in mm.

### without Magic Close

l	lg
20	15
...	...
70	66

### with Magic Close

l	lg
20	15
...	...
70	66

## Head types for d = 4.5 mm, all materials

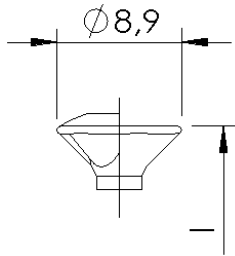

Flat countersunk head 90° with and without raised head, with and without milling pockets

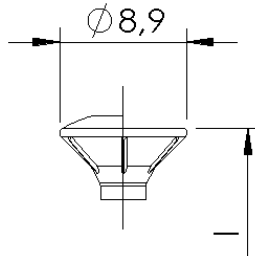

Flat countersunk head 90° with and without raised head, with and without milling ribs

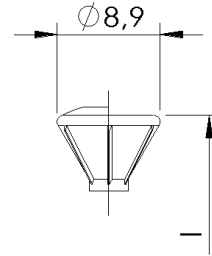

Flat countersunk head 60° / 75°, with and without raised head, with and without milling ribs

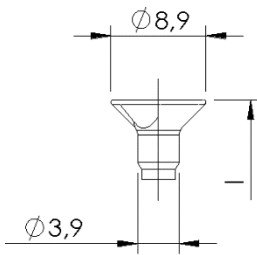

Flat countersunk head 90° with centre drilled hole, with and without milling pockets

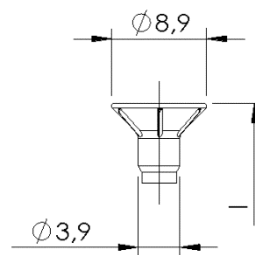

Flat countersunk head 90° with centre drilled hole, with and without milling ribs

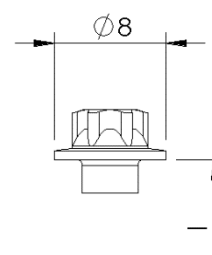

External hexagon head with and without washer

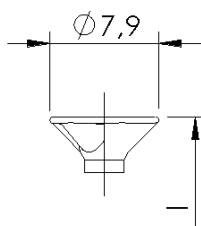

Flat countersunk head 90° with and without milling pockets

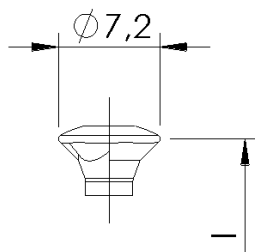

Raised countersunk head 90° with and without milling pockets

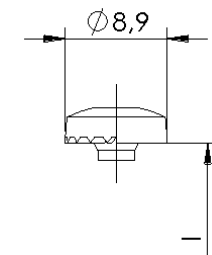

Pan head with and without milling ribs underneath the head

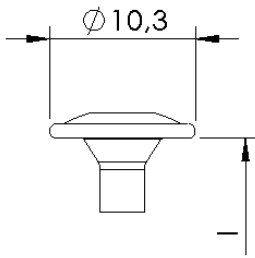

Raised flange head

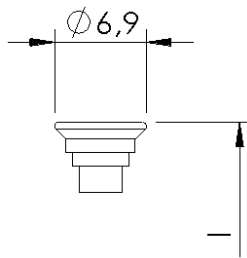

Multi-staged head

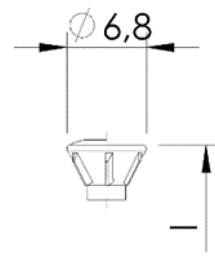

Flat countersunk head 60° / 75°, with and without raised head, with and without milling ribs

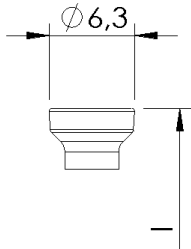

Cylindrical head with countersinking

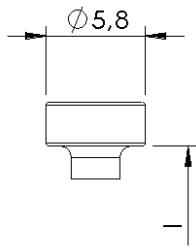

Cylindrical head

### Thread types for d = 4.5 mm, steel

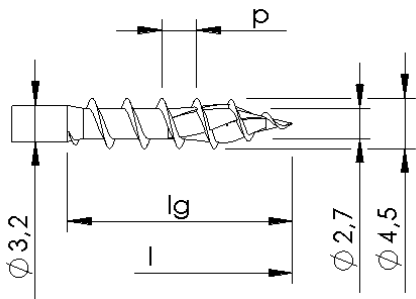

With and without thread variation, with milling ribs

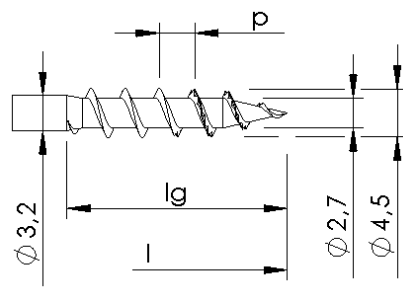

With and without thread variation, with toothed tip

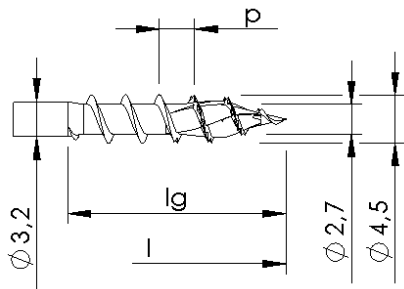

With and without thread variation,  
with toothed tip and milling ribs

### Shank ribs for $d = 4.5$ mm, steel

Shank ribs can be processed as shank rings too. These may be arranged in the same way over the complete shaft or processed in a part of it. All dimensions in mm.

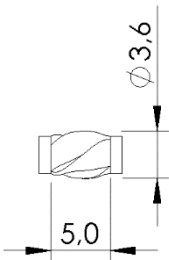

### Lengths for $d = 4.5$ mm, steel

Screws can be processed as full or part threaded, with or without thread variation, without thread in the middle or without thread underneath the head or a combination of both is possible (see "Thread designs"). The thread lengths can be tailored and produced to specific customer requirements in the range of  $l_g$  min and  $l_g$  max. All dimensions in mm.

**without  
Magic Close**

$l$	$l_g$
20	13
...	...
80	60

**with  
Magic Close**

$l$	$l_g$
20	13
...	...
80	76



## Thread types for d = 4.5 mm, stainless steel

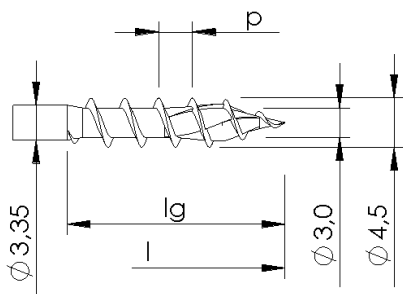

With and without thread variation,  
with milling ribs

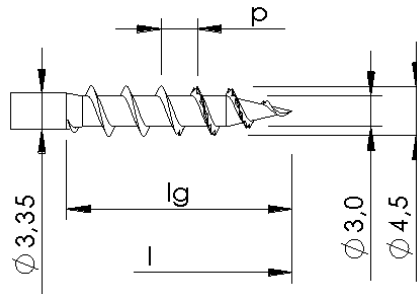

With and without thread variation,  
with toothed tip

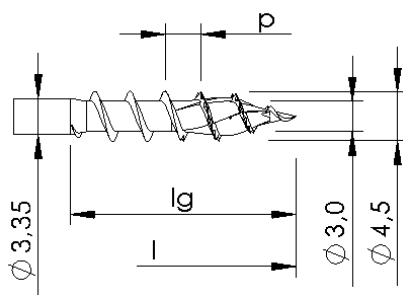

With and without thread variation,  
With toothed tip and milling ribs

## Shank ribs for d = 4.5 mm, stainless steel

Shank ribs can be processed as shank rings too. These may be arranged in the same way over the complete shaft or processed in a part of it. All dimensions in mm.

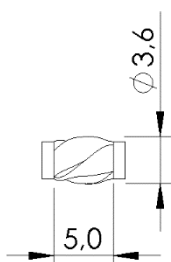

## Lengths for d = 4.5 mm, stainless steel

Screws can be processed as full or part threaded, with or without thread variation, without thread in the middle or without thread underneath the head or a combination of both is possible (see “Thread designs”). The thread lengths can be tailored and produced to specific customer requirements in the range of lg min and lg max. All dimensions in mm.

### without Magic Close

l	lg
20	13
...	...
80	60

### with Magic Close

l	lg
20	13
...	...
80	76

## Head types for d = 5.0 mm, all materials

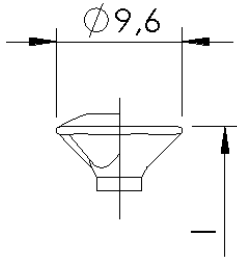

Flat countersunk head 90° with and without raised head, with and without milling pockets

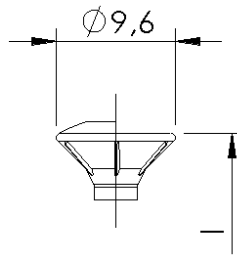

Flat countersunk head 90° with and without raised head, with and without milling ribs

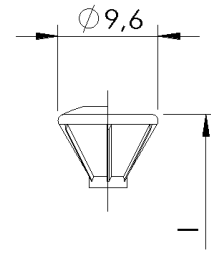

Flat countersunk head 60° / 75°, with and without raised head, with and without milling ribs

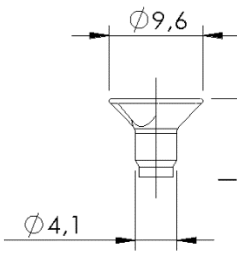

Flat countersunk head 90° with centre drilled hole, with and without milling pockets

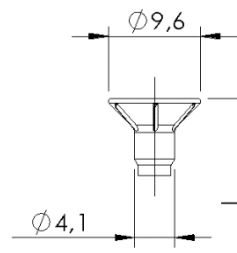

Flat countersunk head 90° with centre drilled hole, with and without milling ribs

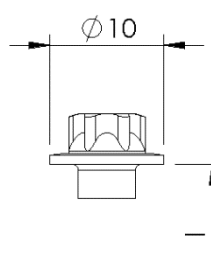

External hexagon head with and without washer

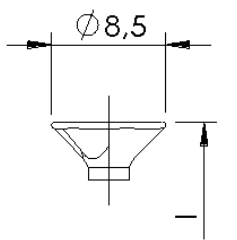

Flat countersunk head 90° with and without milling pockets

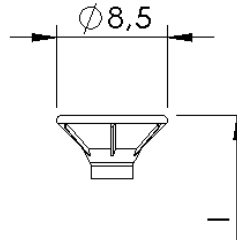

Flat countersunk head 90° with and without milling ribs

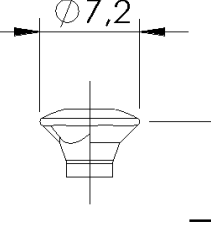

Raised countersunk head 90° with and without milling pockets

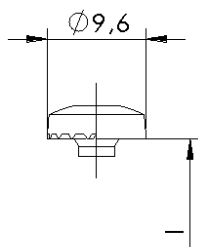

Pan head with and without milling ribs underneath the head

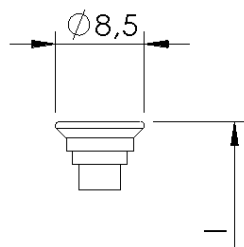

Multi-staged head

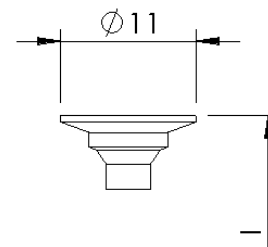

Flat flange head with and without milling ribs

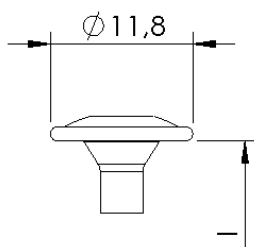

Raised flange head

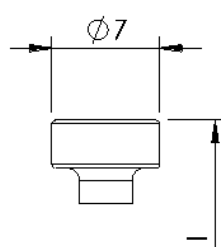

Cylindrical head

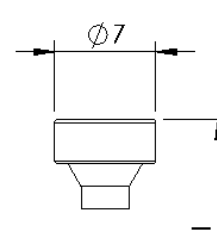

Cylindrical head with countersinking

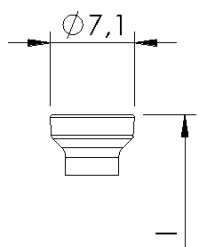

Cylindrical head with countersinking II

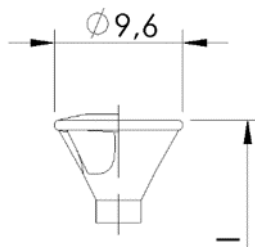

Flat countersunk head 60° / 75°, with and without raised head, with and without milling pockets

## Thread types for d = 5.0 mm, steel

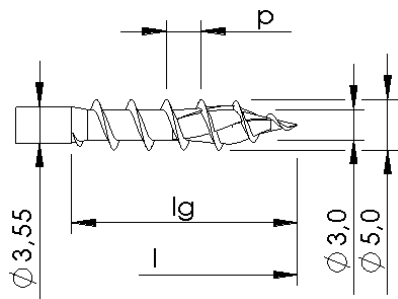

With and without thread variation,  
with milling ribs

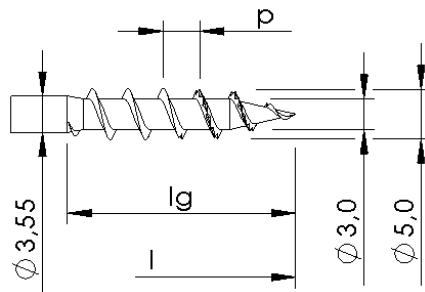

With and without thread variation,  
with toothed tip

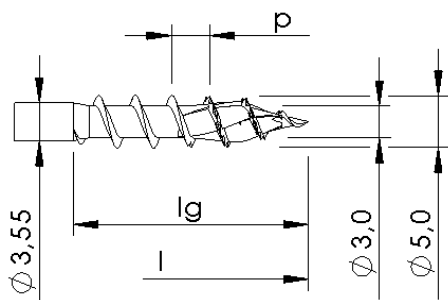

With and without thread variation,  
with toothed tip and milling ribs

## Shank ribs for d = 5.0 mm, steel

Shank ribs can be processed as shank rings too. These may be arranged in the same way over the complete shaft or processed in a part of it. All dimensions in mm.

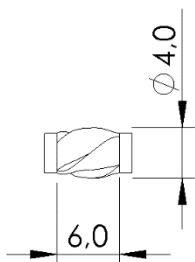

## Lengths for d = 5.0 mm, steel

Screws can be processed as full or part threaded, with or without thread variation, without thread in the middle or without thread underneath the head or a combination of both is possible (see “Thread designs”). The thread lengths can be tailored and produced to specific customer requirements in the range of lg min and lg max. All dimensions in mm.

### without Magic Close

l	lg
25	23
...	...
120	60

### with Magic Close

l	lg
25	23
...	...
120	114

## Thread types for $d = 5.0$ mm, stainless steel

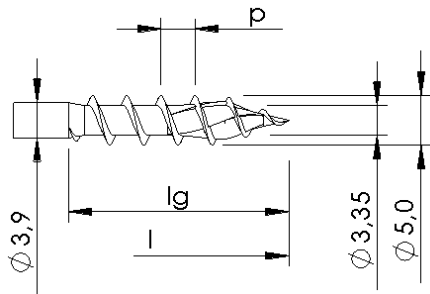

With and without thread variation,  
with milling ribs

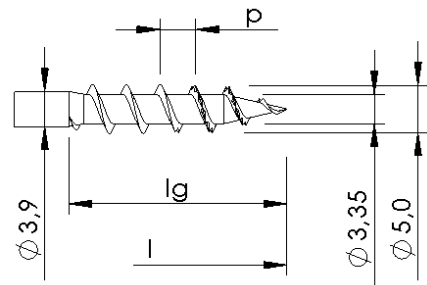

With and without thread variation,  
with toothed tip

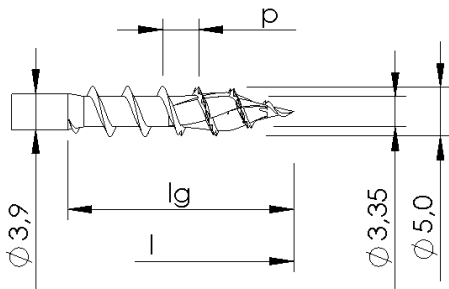

With and without thread variation,  
with toothed tip and milling ribs

## Shank ribs for $d = 5.0$ mm, stainless steel

Shank ribs can be processed as shank rings too. These may be arranged in the same way over the complete shaft or processed in a part of it. All dimensions in mm.

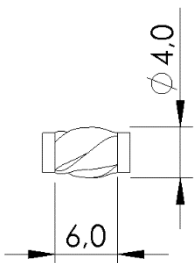

## Lengths for d = 5.0 mm, stainless steel

Screws can be processed as full or part threaded, with or without thread variation, without thread in the middle or without thread underneath the head or a combination of both is possible (see “Thread designs”). The thread lengths can be tailored and produced to specific customer requirements in the range of lg min and lg max. All dimensions in mm.

### without Magic Close

l	lg
25	23
...	...
120	60

### with Magic Close

l	lg
25	23
...	...
80	74



## Head types for d = 6.0 mm, all materials

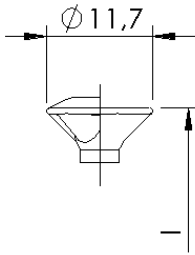

Flat countersunk head 90° with and without raised head, with and without milling pockets

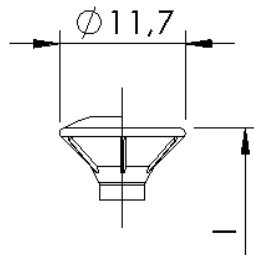

Flat countersunk head 90° with and without raised head, with and without milling ribs

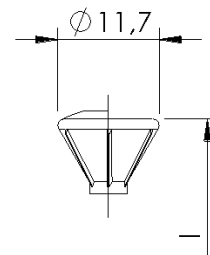

Flat countersunk head 60° / 75°, with and without raised head, with and without milling ribs

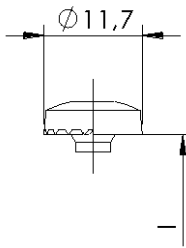

Pan head with and without milling ribs underneath the head

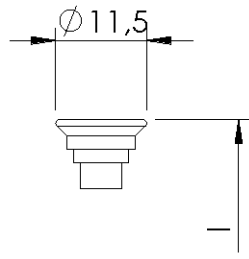

Multi-staged head

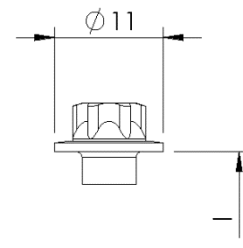

External hexagon head with and without washer

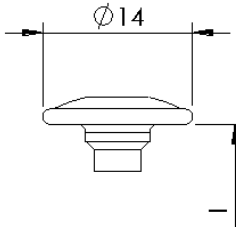

Raised flange head with enlarged shaft

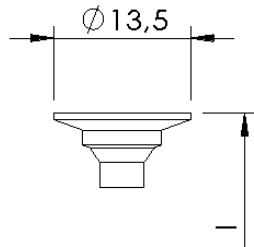

Flat flange head with and without milling ribs

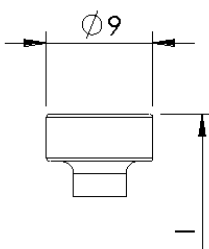

Cylindrical head

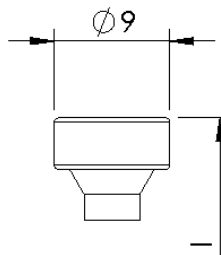

Cylindrical head with countersinking

## Thread types for d = 6.0 mm, steel

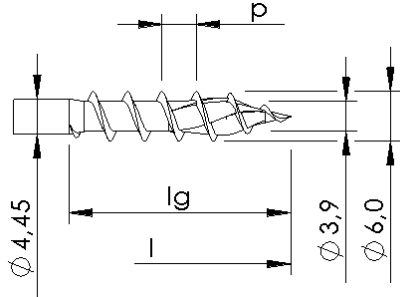

With and without thread variation,  
with milling ribs

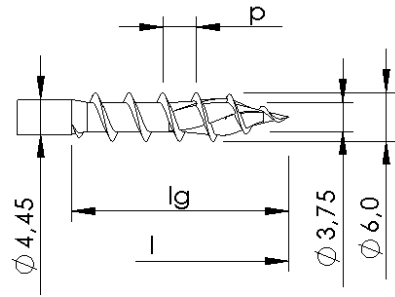

Without thread variation,  
with milling ribs

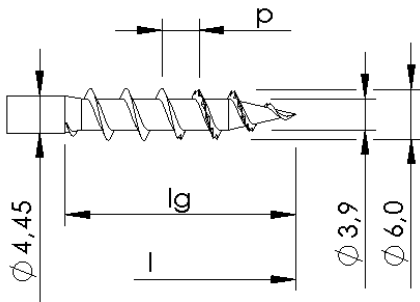

With and without thread variation,  
with toothed tip

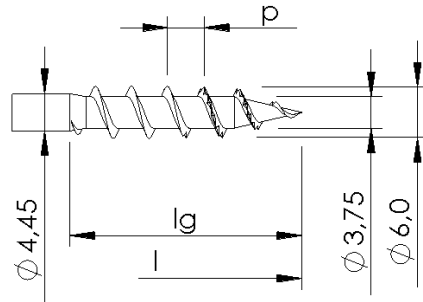

Without thread variation,  
with toothed tip

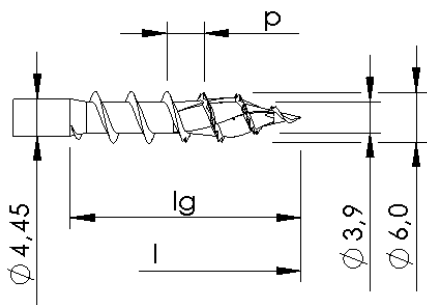

With and without thread variation,  
with toothed tip and milling ribs

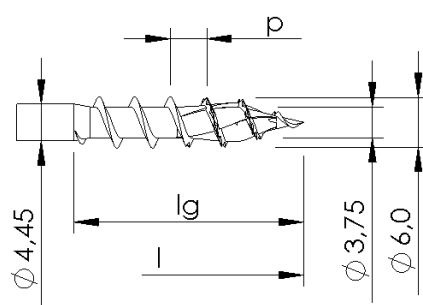

Without thread variation,  
with toothed tip and milling ribs

## Shank ribs for d = 6.0 mm, steel

Shank ribs can be processed as shank rings too. These may be arranged in the same way over the complete shaft or processed in a part of it. All dimensions in mm.

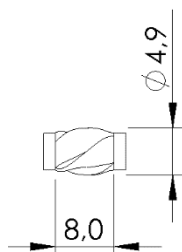

## Lengths for d = 6.0 mm, steel

Screws can be processed as full or part threaded, with or without thread variation, without thread in the middle or without thread underneath the head or a combination of both is possible (see “Thread designs”). The thread lengths can be tailored and produced to specific customer requirements in the range of  $l_{g \text{ min}}$  and  $l_{g \text{ max}}$ . All dimensions in mm.

### without Magic Close

l	lg
30	27
...	...
500	194

### with Magic Close

l	lg
30	27
...	...
160	155

## Thread types for d = 6.0 mm, stainless steel

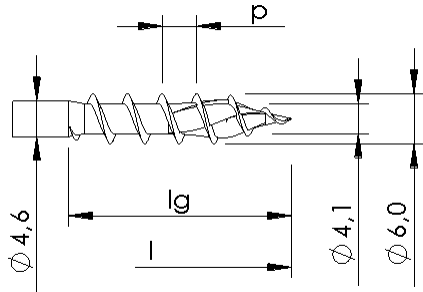

Without thread variation,  
with milling ribs

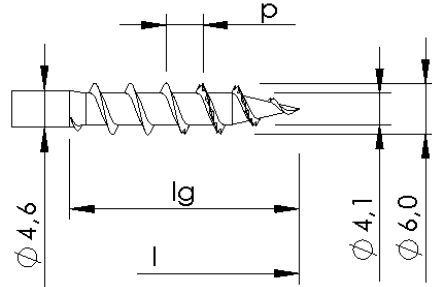

Without thread variation,  
with toothed tip

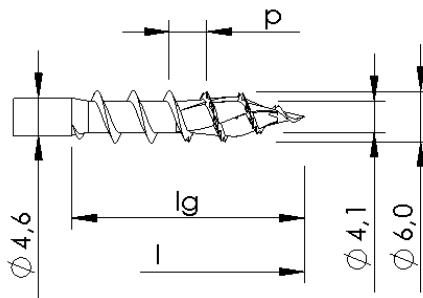

Without thread variation,  
with toothed tip and milling ribs

## Shank ribs for d = 6.0 mm, stainless steel

Shank ribs can be processed as shank rings too. These may be arranged in the same way over the complete shaft or processed in a part of it. All dimensions in mm.

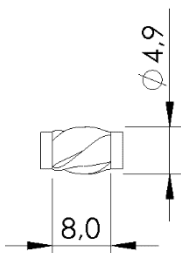

## Lengths for d = 6.0 mm, stainless steel

Screws can be processed as full or part threaded, with or without thread variation, without thread in the middle or without thread underneath the head or a combination of both is possible (see “Thread designs”). The thread lengths can be tailored and produced to specific customer requirements in the range of lg min and lg max. All dimensions in mm.

### without Magic Close

l	lg
30	27
...	...
500	194

### with Magic Close

l	lg
30	27
...	...
80	73

## Head types for $d = 6.5$ mm, all materials

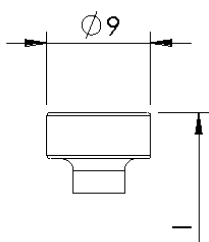

Cylindrical head

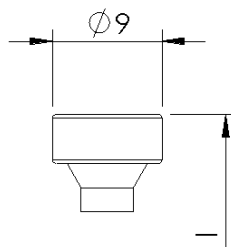

Cylindrical haed with counter-sinking

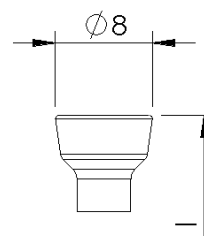

Cylindrical head  $8^\circ$

## Secondary thread for $d = 6.5$ mm, steel

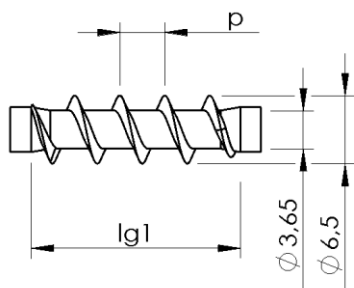

Secondary thread

## Thread types for d = 6.5 mm, steel

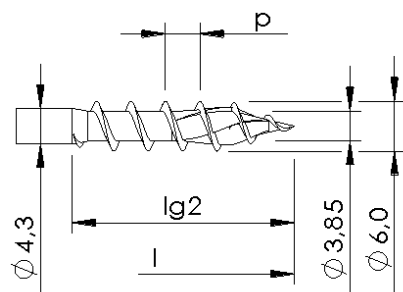

Without thread variation,  
with milling ribs

## Lengths for d = 6.5 mm, steel

Screws can be processed as full or part threaded, with or without thread variation, without thread in the middle or without thread underneath the head or a combination of both is possible (see “Thread designs”). The thread lengths can be tailored and produced to specific customer requirements in the range of lg min and lg max. All dimensions in mm.

**without  
Magic Close**

l	lg1	lg2
100	45	45
...	...	...
215	100	100

## Head types for d = 8.0 mm, all materials

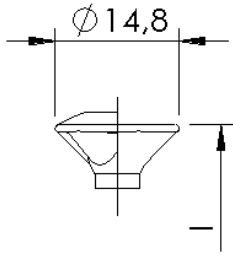

Flat countersunk head 90° with and without raised head, with and without milling pockets

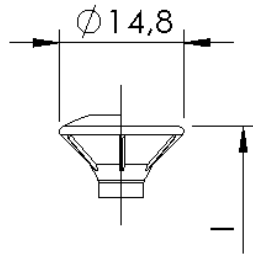

Flat countersunk head 90° with and without raised head, with and without milling ribs

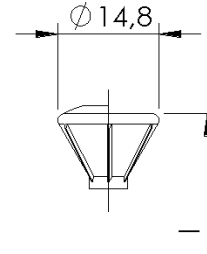

Flat countersunk head 60° / 75°, with or without raised head, with or without milling ribs

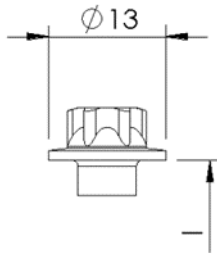

External hexagon head with and without washer

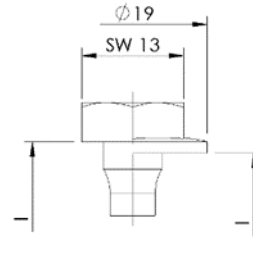

Hexagon head with and without washer

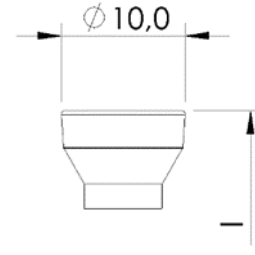

Cylindrical head with counter-sinking

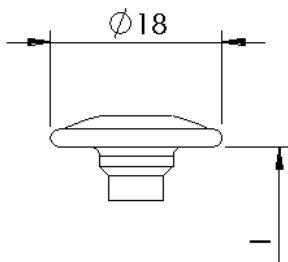

Raised flange head

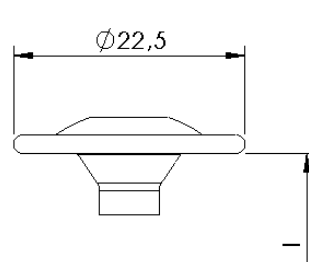

Raised flange head with big washer

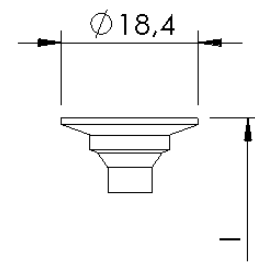

Flat flange head with and without milling ribs

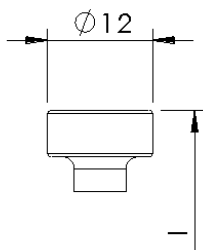

Cylindrical head

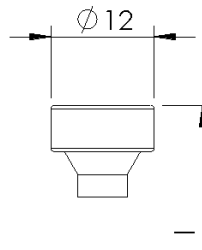

Cylindrical head with counter-sinking

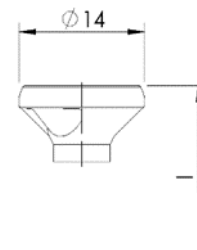

Flat countersunk head 90°, with and without milling pockets



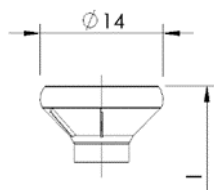

Flat countersunk head 90°, with  
and without milling ribs

### Secondary thread for $d = 8.0$ mm, steel

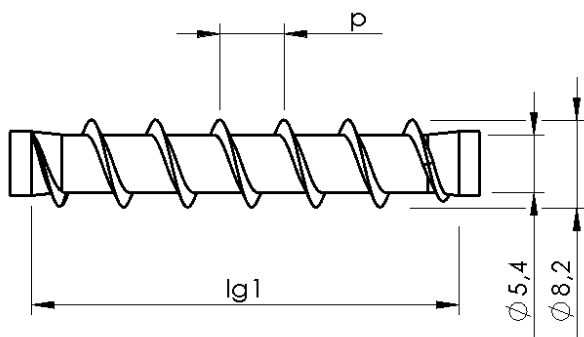

Secondary thread

### Thread types for $d = 8.0$ mm, steel

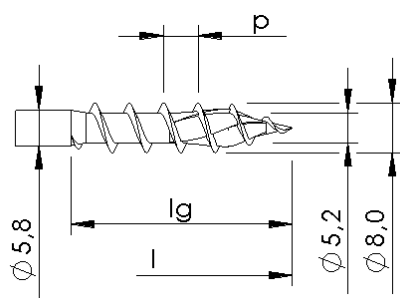

With and without thread variation,  
with milling ribs

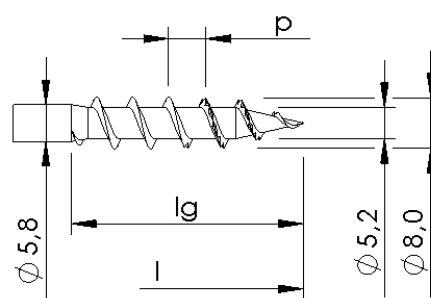

With and without thread variation,  
with toothed tip

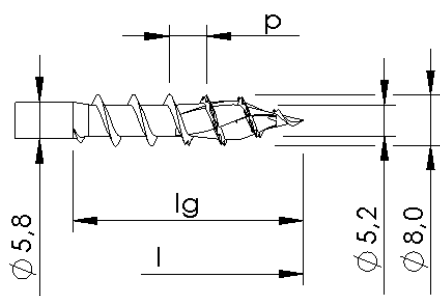

With and without thread variation,  
with toothed tip and milling ribs

### Thread types for HECO-TOPIX-plus T d = 8.0 mm, steel

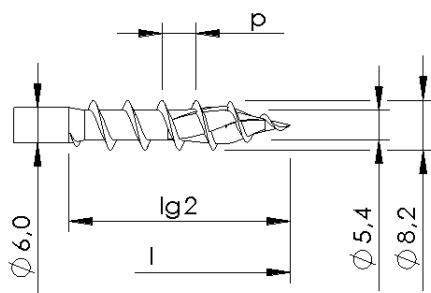

Without thread variation, with milling ribs

### Shank ribs for d = 8.0 mm, steel

Shank ribs can be processed as shank rings too. These may be arranged in the same way over the complete shaft or processed in a part of it. All dimensions in mm.

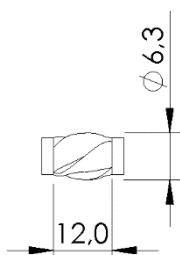

## Lengths for d = 8.0 mm, steel

Screws can be processed as full or part threaded, with or without thread variation, without thread in the middle or without thread underneath the head or a combination of both is possible (see “Thread designs”). The thread lengths can be tailored and produced to specific customer requirements in the range of lg min and lg max. All dimensions in mm.

**without  
Magic Close**

<b>l</b>	<b>lg</b>
40	35
...	...
640	632

## Lengths for HECO-TOPIX-plus T d = 8.0 mm, steel

**without  
Magic Close**

<b>l</b>	<b>lg1</b>	<b>lg2</b>
160	60	70
...	...	...
600	60	100

## Secondary thread for $d = 8.0$ mm, stainless steel

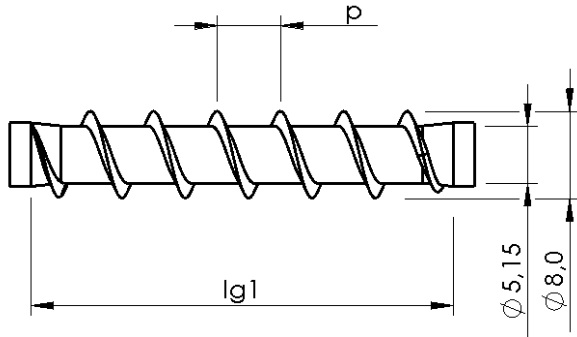

Secondary thread

## Thread types for $d = 8.0$ mm, stainless steel

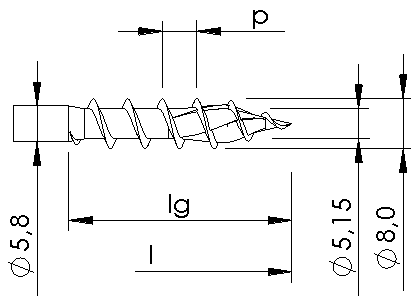

With and without thread variation,  
with milling ribs

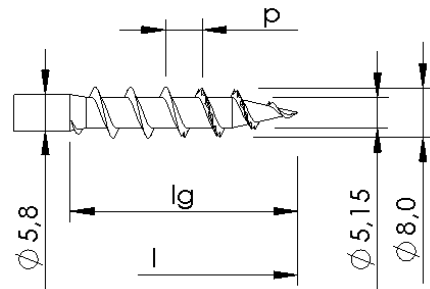

With and without thread variation,  
with toothed tip

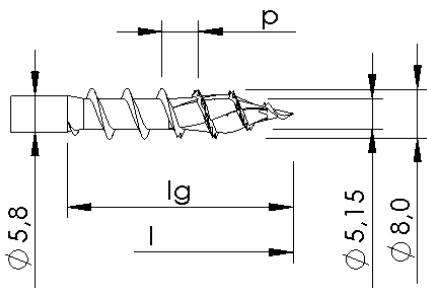

With and without thread variation,  
with toothed tip and milling ribs

## Thread types for HECO-TOPIX-plus T d = 8.0 mm, stainless steel

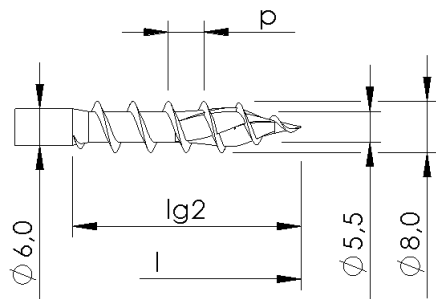

Without thread variation,  
with milling ribs

## Shank ribs for d = 8.0 mm, stainless steel

Shank ribs can be processed as shank rings too. These may be arranged in the same way over the complete shaft or processed in a part of it. All dimensions in mm.

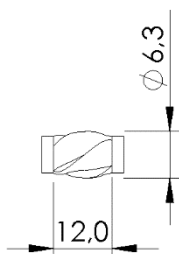

## Lengths for d = 8.0 mm, stainless steel

Screws can be processed as full or part threaded, with or without thread variation, without thread in the middle or without thread underneath the head or a combination of both is possible (see “Thread designs”). The thread lengths can be tailored and produced to specific customer requirements in the range of lg min and lg max. All dimensions in mm.

**without  
Magic Close**

<b>l</b>	<b>lg</b>
40	35
...	...
600	372

## Lengths for HECO-TOPIX-plus T d = 8.0 mm, stainless steel

**without  
Magic Close**

<b>l</b>	<b>lg1</b>	<b>lg2</b>
160	60	70
...	...	...
600	60	100

## Head types for $d = 8.5$ mm, all materials

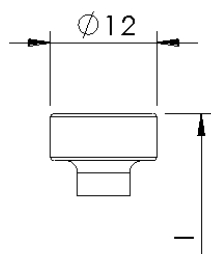

Cylindrical head

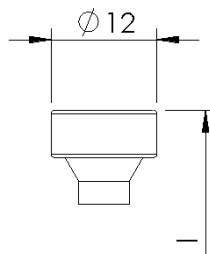

Cylindrical head with counter-sinking

## Secondary thread for $d = 8.5$ mm, steel

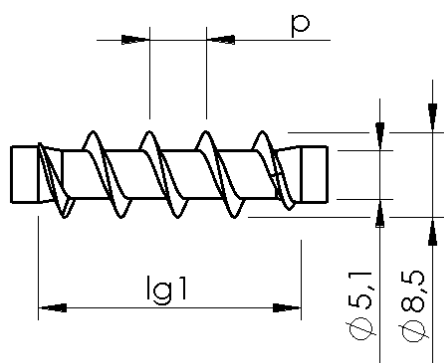

Secondary thread

## Thread types for d = 8.5 mm, steel

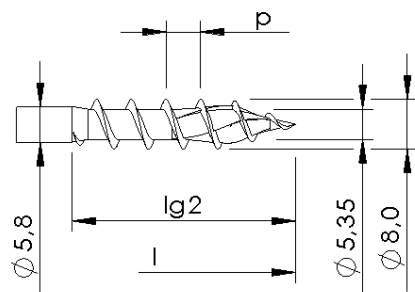

Without thread variation,  
with milling ribs

## Lengths for d = 8.5 mm, steel

Screws can be processed as full or part threaded, with or without thread variation, without thread in the middle or without thread underneath the head or a combination of both is possible (see “Thread designs”). The thread lengths can be tailored and produced to specific customer requirements in the range of lg min and lg max. All dimensions in mm.

**without  
Magic Close**

l	lg1	lg2
100	45	45
...	...	...
350	158	158



## Head types for d = 10.0 mm, all materials

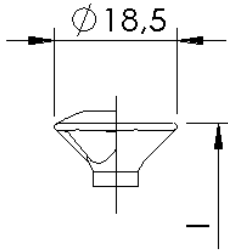

Flat countersunk head 90° with and without raised head, with and without milling pockets

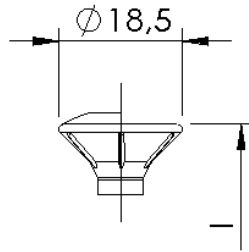

Flat countersunk head 90° with and without raised head, with and without milling ribs

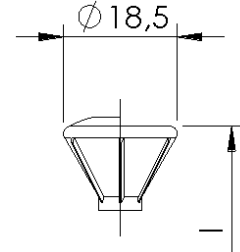

Flat countersunk head 60° / 75°, with or without raised head, with or without milling ribs

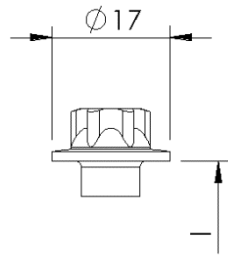

External hexagon head with or without washer

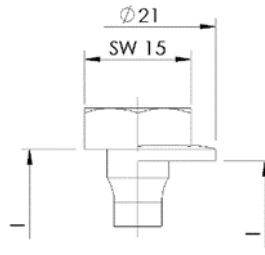

Hexagon head with and without washer

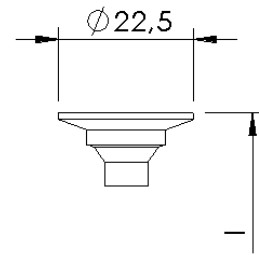

Flat flange head with and without milling ribs

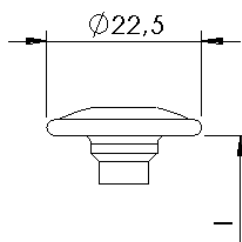

Raised flange head

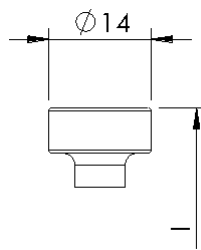

Cylindrical head

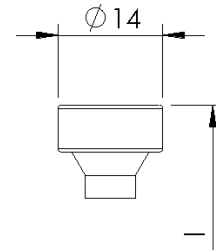

Cylindrical head with Countersinking

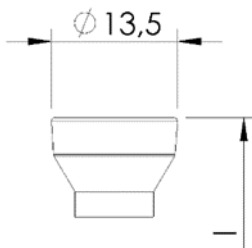

Cylindrical head with Countersinking

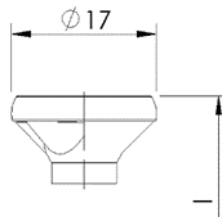

Flat countersunk head 90°, with and without milling pockets

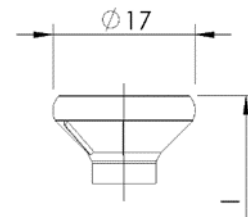

Flat countersunk head 90°, with and without milling ribs

## Secondary thread for $d = 10.0$ mm, steel

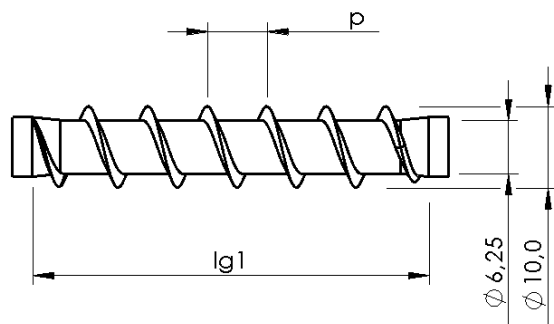

Secondary thread

## Thread types for $d = 10.0$ mm, steel

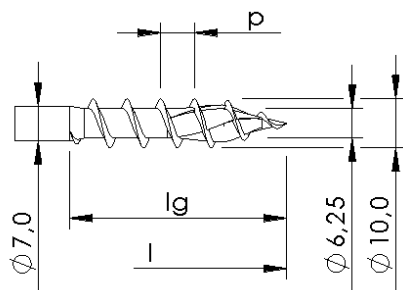

With and without thread variation,  
with milling ribs

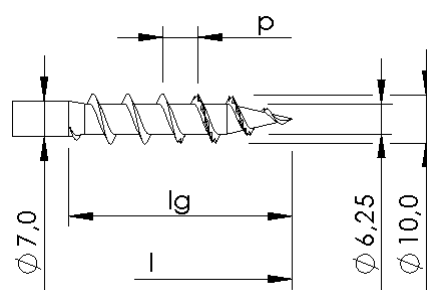

With and without thread variation,  
with toothed tip

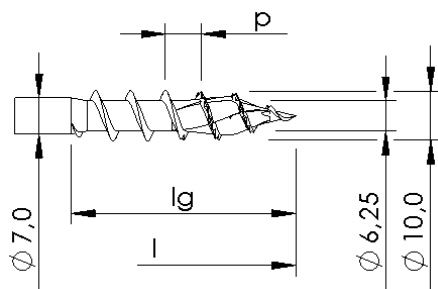

With and without thread variation,  
with toothed tip and milling ribs

Thread types for HECO-TOPIX-plus T d = 10.0 mm, steel

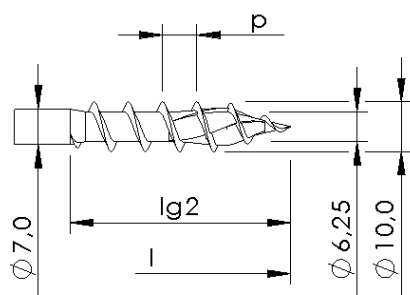

Without thread variation,  
with milling ribs

### Shank ribs for d = 10.0 mm, steel

Shank ribs can be processed as shank rings too. These may be arranged in the same way over the complete shaft or processed in a part of it. All dimensions in mm.

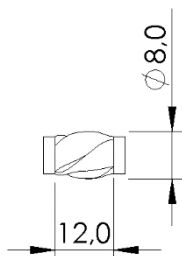

## Lengths for d = 10.0 mm, steel

Screws can be processed as full or part threaded, with or without thread variation, without thread in the middle or without thread underneath the head or a combination of both is possible (see “Thread designs”). The thread lengths can be tailored and produced to specific customer requirements in the range of lg min and lg max. All dimensions in mm.

**without  
Magic Close**

<b>l</b>	<b>lg</b>
60	50
...	...
500	370

## Lengths for HECO-TOPIX- plus T d = 10.0 mm, steel

**without  
Magic Close**

<b>l</b>	<b>lg1</b>	<b>lg2</b>
200	60	100
...	...	...
500	60	100

## Thread types for d = 10.0 mm, stainless steel

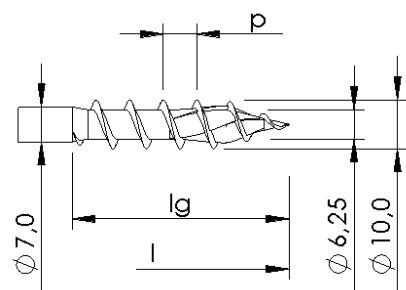

With and without thread variation,  
with milling ribs

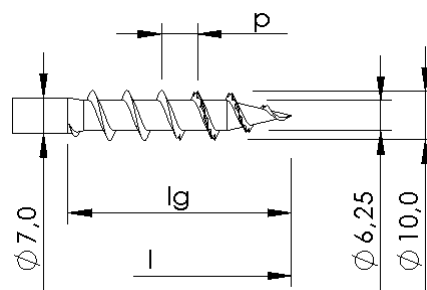

With and without thread variation,  
with toothed tip

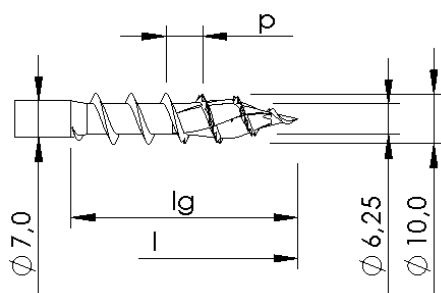

With and without thread variation,  
with toothed tip and milling ribs

## Thread types for HECO-TOPIX-plus T d = 10.0 mm, stainless steel

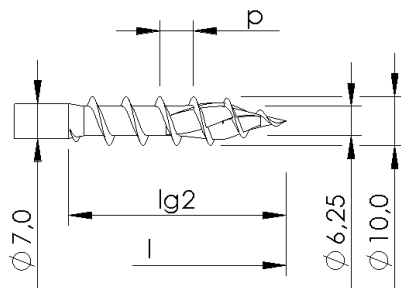

Without thread variation,  
with toothed tip and milling ribs

## Shank ribs for d = 10.0 mm, stainless steel

Shank ribs can be processed as shank rings too. These may be arranged in the same way over the complete shaft or processed in a part of it. All dimensions in mm.

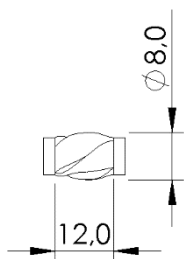

## Lengths for d = 10.0 mm, stainless steel

Screws can be processed as full or part threaded, with or without thread variation, without thread in the middle or without thread underneath the head or a combination of both is possible (see “Thread designs”). The thread lengths can be tailored and produced to specific customer requirements in the range of lg min and lg max. All dimensions in mm.

**without  
Magic Close**

<b>l</b>	<b>lg2</b>
60	50
...	...
500	370

## Lengths for HECO-TOPIX- plus T d = 10.0 mm, stainless steel

**without  
Magic Close**

<b>l</b>	<b>lg1</b>	<b>lg2</b>
200	60	100
...	...	...
500	60	100

## Head markings

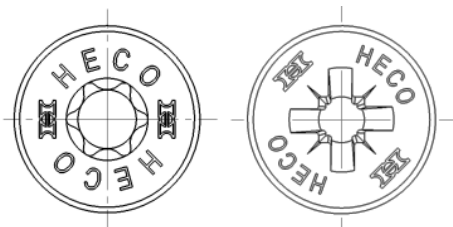

Head markings for  $d = 3.5$  to  $6.5$  mm all head types  
Head types without lettering possible.



Head markings for  $d = 7.0$  bis  $10.0$  mm all head types  
Head types without lettering possible.



Head markings for  $d = 6.0$  to  $10.0$  of types: flat countersunk head.  
Specified type without lettering possible too.

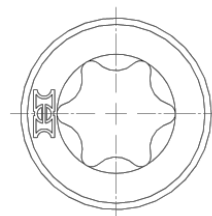

Head markings for  $d = 4,5$  to  $10.0$  of types: Cylindrical head, cylindrical head with countersinking.  
Specified type without lettering possible too.



## HECO-washers, steel and stainless steel

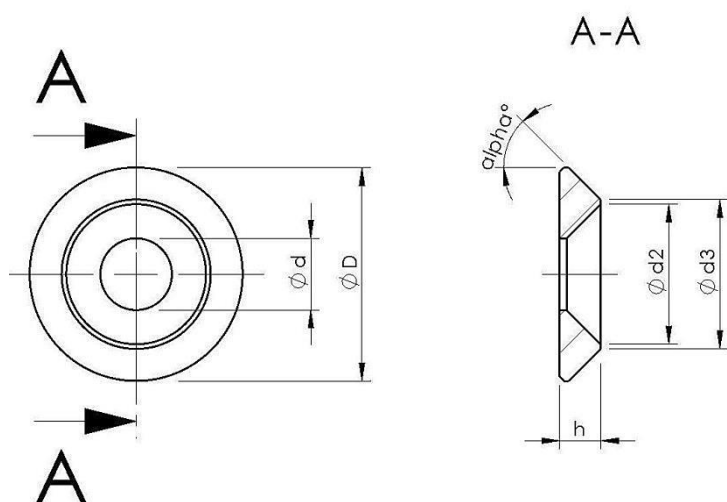

Size	d (mm)	D (mm)	H (mm)	Alpha (°)	d2 (mm)	d3 (mm)
8	8.5	25	4.8	45	16.4	17.5
10	10.5	30	6.6	45	21.0	22.5

## Annex B

### Spacing, end and edge distances of the screws and minimum thickness of the wood based material

#### Laterally and/or axially loaded screws

##### *Screws in pre-drilled holes*

For HECO screws in pre-drilled holes the minimum spacings, end and edge distances are given in EN 1995-1-1, clause 8.3.1.2 and Table 8.2 as for nails in pre-drilled holes. Here, the outer thread diameter  $d$  shall be considered.

##### HECO-TOPIX-plus screws

Minimum thickness for structural timber members made from solid timber, glued laminated timber, glued solid timber, laminated veneer lumber and cross laminated timber is  $t = 24$  mm for screws with  $d \leq 6$  mm,  $t = 30$  mm for screws with  $d = 8$  mm and  $t = 40$  mm for screws with  $d = 10$  mm.

##### HECO-TOPIX-plus-CC and HECO-TOPIX-plus-T screws

Minimum thickness for structural timber members made from solid timber, glued laminated timber, glued solid timber, laminated veneer lumber and cross laminated timber is  $t = 30$  mm for screws with  $d \leq 8$  mm and  $t = 40$  mm for screws with  $d = 10$  mm. In the case the spacing parallel to the grain and the end distance is at least  $25 \cdot d$  the minimum thickness for structural members is  $t = 24$  mm for screws with  $d = 6$  mm.

##### *Screws in non pre-drilled holes*

For HECO screws minimum spacing and distances are given in EN 1995-1-1, clause 8.3.1.2 and Table 8.2 as for nails in non-predrilled holes. Here, the outer thread diameter  $d$  shall be considered.

For Douglas fir members minimum spacing and distances parallel to the grain shall be increased by 50%.

Minimum distances from loaded or unloaded ends shall be at least  $15 \cdot d$  for screws with outer thread diameter  $d > 8$  mm and timber thickness  $t < 5 \cdot d$ .

Minimum distances from the unloaded edge perpendicular to the grain may be reduced to  $3 \cdot d$  also for timber thickness  $t < 5 \cdot d$ , if the spacing parallel to the grain and the end distance is at least  $25 \cdot d$ .

Minimum thickness for non-predrilled structural softwood members is  $t = 24$  mm for screws with outer thread diameter  $d < 8$  mm,  $t = 30$  mm for screws with outer thread diameter  $d = 8$  mm and  $t = 40$  mm for screws with outer thread diameter  $d = 10$  mm, if the spacing parallel to the grain and the end distance is at least  $25 \cdot d$ .

In all other cases, minimum thicknesses for HECO screws in non-predrilled softwood timber members are given in EN 1995-1-1, clause 8.3.1.2 as for nails in non-predrilled holes.

#### Only axially loaded screws

For HECO screws (without MagicClose) loaded only axially, the following minimum spacings, end and edge distances apply alternatively for solid timber, glued laminated timber and similar glued products:

Spacing $a_1$ in a plane parallel to grain:	$a_1 = 5 \cdot d$
Spacing $a_2$ perpendicular to a plane parallel to grain:	$a_2 = 2.5 \cdot d$
End distance of the centre of gravity of the threaded part in the timber member:	$a_{1,CG} = 5 \cdot d$
Edge distance of the centre of gravity of the threaded part in the timber member:	$a_{2,CG} = 4 \cdot d$
Product of spacing $a_1$ and $a_2$ :	$a_1 \cdot a_2 = 25 \cdot d^2$

For screws in non pre-drilled holes a minimum timber thickness of  $12 \cdot d$  and a minimum width of  $8 \cdot d$  or 60 mm, whichever is the greater, are required.

For a crossed screw couple in solid timber, glued laminated timber and similar glued products or in laminated veneer lumber the minimum spacing between the crossing screws is  $1.5 \cdot d$ . Appropriate means have to ensure that the crossed screw threads do not touch each other when being screwed in the timber member.

Are the spacing, end and edge distances less than the distances and thicknesses given in EN 1995-1-1 the verification of resistance according to EN 1995-1-1, clause 8.7.2 (1) the failure along the circumference of a group of screws has to be considered also for connections without steel plates.

Minimum distances from the unloaded edge perpendicular to the grain of I-joist flanges made of LVL may be reduced to  $2 \cdot d$  for  $d \leq 8$  mm and timber thickness  $t \geq 39$  mm, if the spacing parallel to the grain and the end distance are at least  $10 \cdot d$ . The screws shall be centrally inserted in the I-joist flanges.

**Cross laminated timber**

The minimum requirements for spacing, end and edge distances of HECO-Topix-plus, Heco-TOPIX-plus-CC or Heco-TOPIX-plus-T screws in the plane or edge surfaces of cross laminated timber are summarised in Table 5. The definition of spacing, end and edge distance is shown in the Figure 1 and Figure 2. The minimum spacing, end and edge distances in the edge surfaces are independent of the angle between screw axis and grain direction. They may be used based on the following conditions:

- Minimum thickness of cross laminated timber:  $10 \cdot d$
- Minimum penetration depth in the edge surface:  $10 \cdot d$

Table 5: Minimum spacing, end and edge distances of screws in the plane or edge surfaces of cross laminated timber

	$a_1$	$a_{3,t}$	$a_{3,c}$	$a_2$	$a_{4,t}$	$a_{4,c}$
Plane surface (see Figure A.2.1)	$4 \cdot d$	$6 \cdot d$	$6 \cdot d$	$2,5 \cdot d$	$6 \cdot d$	$2,5 \cdot d$
Edge surface (see Figure A.2.2)	$10 \cdot d$	$12 \cdot d$	$7 \cdot d$	$4 \cdot d$	$6 \cdot d$	$3 \cdot d$

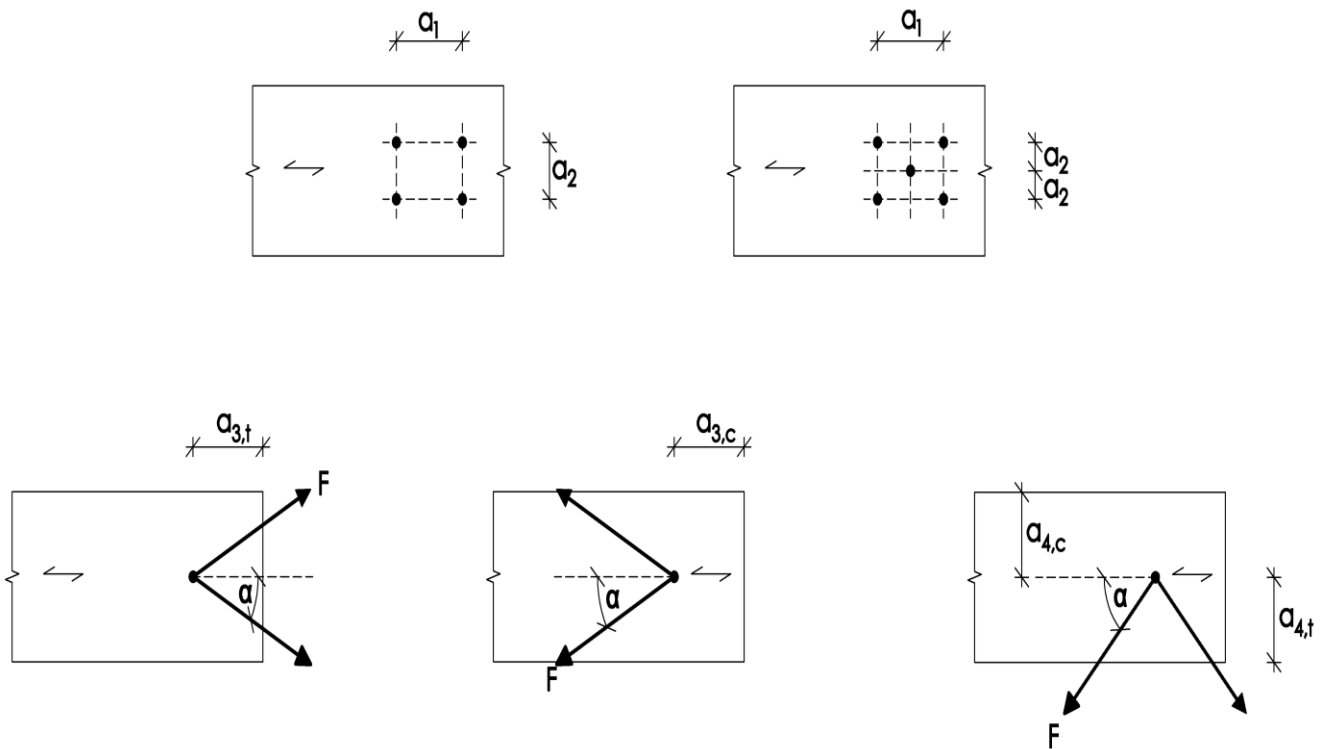

Figure 1: Definition of spacing, end and edge distances in the plane surface

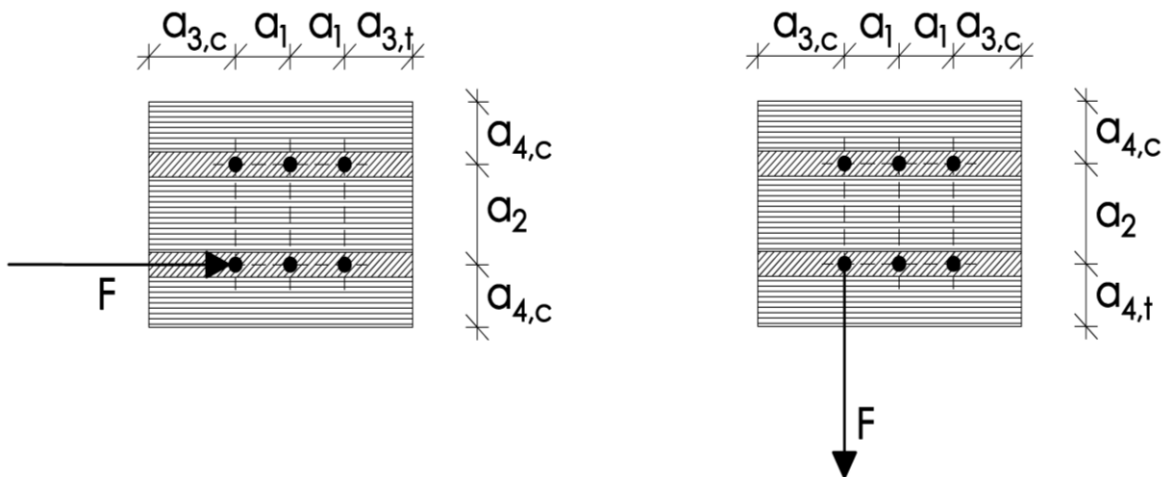

Figure 2: Definition of spacing, end and edge distances in the edge surface

Use examples of HECO-TOPIX-plus-T, HECO-TOPIX-plus-CC screws and fully threaded HECO-TOPIX-plus screws

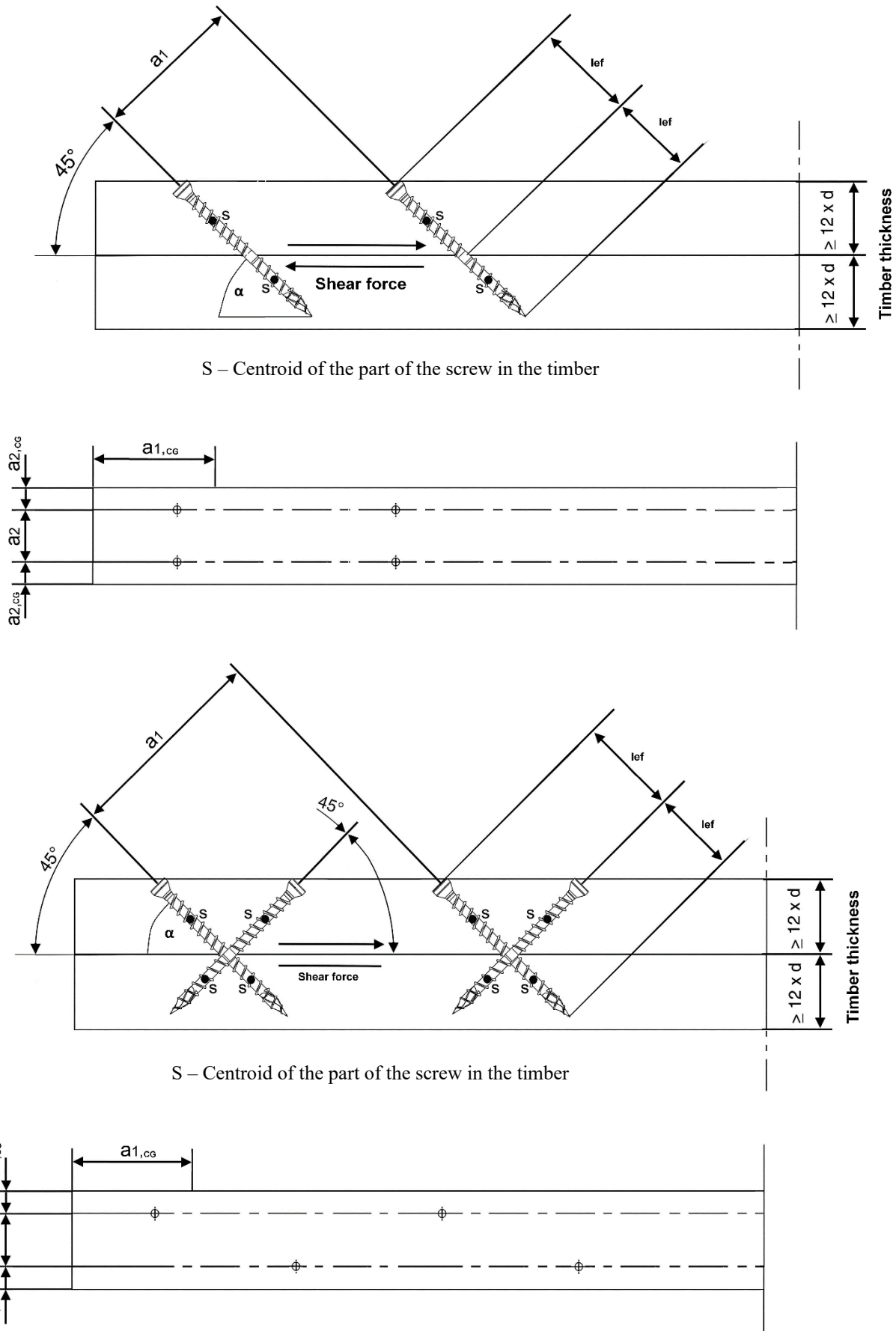

Figure 3: Centroid of the part of the screw in the timber

## Annex C

### Compressive capacity of HECO-TOPIX-plus-CC screws and fully threaded HECO-TOPIX-plus screws - Characteristic yield strength

The design axial capacity  $F_{ax,Rd}$  of HECO-TOPIX-CC screws and fully threaded HECO-TOPIX-plus screws embedded in solid timber, glued solid timber or glued laminated timber made from softwood with an angle between screw axis and grain direction of  $30^\circ \leq \alpha \leq 90^\circ$  is the minimum of the axial resistance against pushing-in and the buckling resistance of the screw.

$$F_{ax,Rd} = \min \left\{ f_{ax,d} \cdot d \cdot \ell_{ef}; \kappa_c \cdot N_{pl,d} \right\}$$

$f_{ax,d}$  design value of the axial withdrawal capacity of the threaded part of the screw [N/mm<sup>2</sup>]

$d$  outer thread diameter of the screw [mm]

$\ell_{ef}$  penetration length of the threaded part of the screw in the timber member [mm]

$$\kappa_c = 1 \quad \text{for } \bar{\lambda}_k \leq 0,2$$

$$\kappa_c = \frac{1}{k + \sqrt{k^2 - \bar{\lambda}_k^2}} \quad \text{for } \bar{\lambda}_k > 0,2$$

$$k = 0,5 \cdot \left[ 1 + 0,49 \cdot (\bar{\lambda}_k - 0,2) + \bar{\lambda}_k^2 \right]$$

and a relative slenderness ratio  $\bar{\lambda}_k = \sqrt{\frac{N_{pl,k}}{N_{ki,k}}}$

where:

$N_{pl,k}$  characteristic plastic normal force related to the net cross-section of the inner thread diameter: :

$$N_{pl,k} = \pi \cdot \frac{d_1^2}{4} \cdot f_{y,k}$$

$f_{y,k}$  characteristic yield strength,  $f_{y,k} = 900$  N/mm<sup>2</sup> for HECO-TOPIX-plus-CC screws and fully threaded HECO-TOPIX-plus screws

$d_1$  inner thread diameter of the screw [mm]

$$N_{pl,d} = \frac{N_{pl,k}}{\gamma_{M1}}$$

$\gamma_{M1}$  partial factor according to EN 1993-1-1 in conjunction with the particular national annex characteristic ideal elastic buckling load:

$$N_{ki,k} = \sqrt{c_h \cdot E_s \cdot I_s} \quad [\text{N}]$$

elastic foundation of the screw:

$$c_h = (0.19 + 0.012 \cdot d) \cdot \rho_k \cdot \left( \frac{90^\circ + \alpha}{180^\circ} \right) \quad [\text{N/mm}^2]$$

$\rho_k$  characteristic density of the timber member [kg/m<sup>3</sup>],

$\alpha$  angle between screw axis and grain direction,  $30^\circ \leq \alpha \leq 90^\circ$

modulus of elasticity:

$$E_s = 210.000 \text{ N/mm}^2$$

second moment of area:

$$I_s = \frac{\pi \cdot d_1^4}{64} \quad [\text{mm}^4]$$

## Annex D

### Compression reinforcement perpendicular to the grain

#### General

Only HECO-TOPIX-plus-CC screws and fully threaded HECO-TOPIX-plus screws shall be used for compression reinforcement perpendicular to the grain. The provisions are valid for reinforcing timber members made from solid timber, glued solid timber and glued laminated timber made from softwood.

The compression force shall evenly be distributed to the screws used as compression reinforcement.

The screws are driven into the timber member perpendicular to the contact surface under an angle between the screw axis and the grain direction of 45° to 90°. The screw heads must be flush with the timber surface.

#### Design

For the design of reinforced contact areas the following conditions must be met independently of the angle between the screw axis and the grain direction.

The design resistance of a reinforced contact area is:

$$R_{90,d} = \min \left\{ \begin{array}{l} k_{c,90} \cdot B \cdot \ell_{ef,1} \cdot f_{c,90,d} + n \cdot \min \{ R_{ax,d}; \kappa_c \cdot N_{pl,d} \} \\ B \cdot \ell_{ef,2} \cdot f_{c,90,d} \end{array} \right\}$$

where:

$k_{c,90}$  Parameter according to EN 1995-1-1:2004+A1: 2008, 6.1.5

$B$  Bearing width [mm]

$\ell_{ef,1}$  Effective contact length according to EN 1995-1-1:2004+A1: 2008, 6.1.5 [mm]

$f_{c,90,d}$  Design compressive strength perpendicular to the grain [N/mm<sup>2</sup>]

$n$  Number of reinforcing screws,  $n = n_0 \cdot n_{90}$

$n_0$  Number of reinforcing screws arranged in a row parallel to the grain

$n_{90}$  Number of reinforcing screws arranged in a row perpendicular to the grain

$$R_{ax,d} = f_{ax,d} \cdot d \cdot \ell_{ef} \quad [N]$$

$f_{ax,d}$  design value of the axial withdrawal capacity of the threaded part of the screw [N/mm<sup>2</sup>]

$d$  outer thread diameter of the screw [mm]

$\kappa_c$  according to annex C, section "compressive capacity"

$N_{pl,d}$  according to annex C, section "compressive capacity" [N]

$\ell_{ef,2}$  Effective contact length in the plane of the screw tips (see following Figure) [mm]

$$\ell_{ef,2} = \{ \ell_{ef} + (n_0 - 1) \cdot a_1 + \min(\ell_{ef}; a_{1,CG}) \} \text{ for end supports (see following Figure left)}$$

$$\ell_{ef,2} = \{ 2 \cdot \ell_{ef} + (n_0 - 1) \cdot a_1 \} \text{ for intermediate supports (see Figure 4 right)}$$

$\ell_{ef}$  Penetration length of the threaded part of the screw in the timber member [mm]

$a_1$  Spacing  $a_1$  in a plane parallel to grain, see Annex B [mm]

$a_{1,CG}$  End distance of the centre of gravity of the threaded part in the timber member, see Annex B [mm]

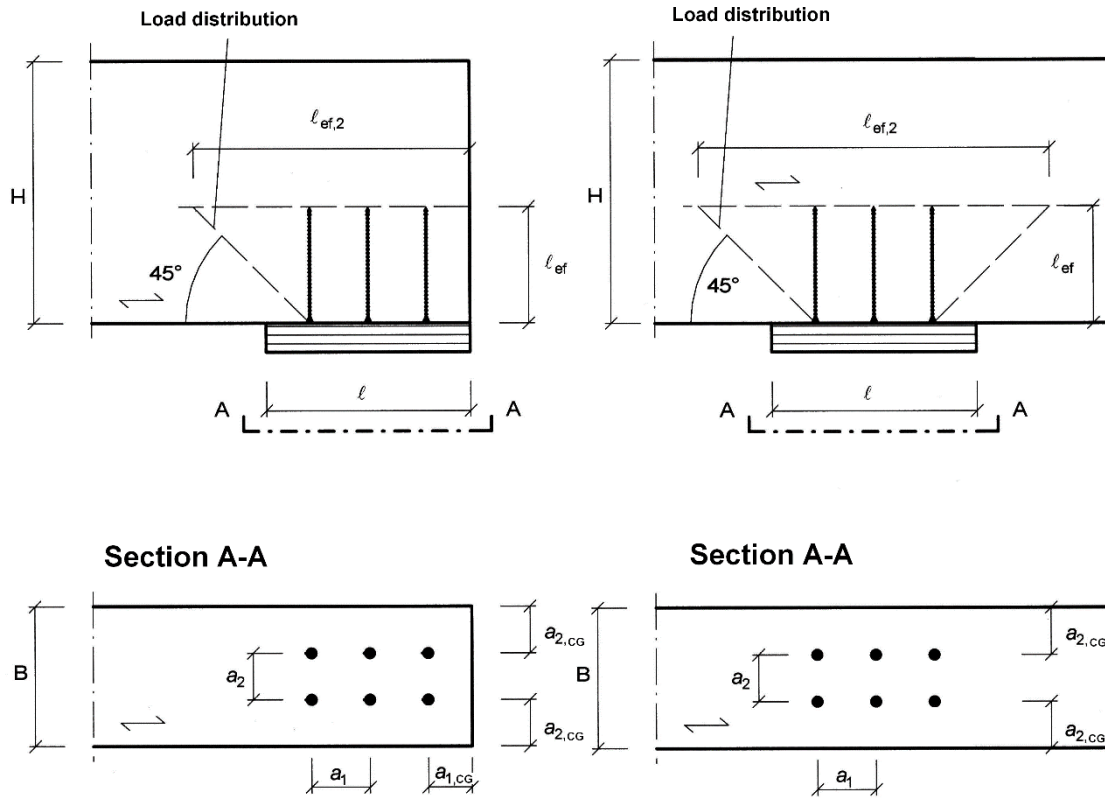

Figure 4: Reinforced end support (left) and reinforced intermediate support (right)

## Annex E

### Tensile reinforcement perpendicular to grain

#### General

Only HECO-TOPIX-plus-CC screws and fully threaded HECO-TOPIX-plus screws shall be used for tensile reinforcement perpendicular to the grain.

The screws are driven into the timber member perpendicular to the contact surface under an angle between the screw axis and the grain direction of 90°.

The provisions regarding tensile reinforcement perpendicular to the grain are valid for the following timber members:

- solid timber made of softwood or of the hardwood species ash, beech or oak,
- glued laminated timber made of softwood or of the hardwood species ash, beech or oak,
- glued solid timber made of softwood,
- laminated veneer lumber made of softwood.

For the design and construction of the tensile reinforcement of timber members perpendicular to the grain, the provisions at the place of installation shall apply. As examples connection forces at an angle to the grain and notched beam supports are given in the following.

Note: For example, in Germany the provisions of standard DIN EN 1995-1-1/NA: 2013-08, NCI NA.6.8 and amendments shall be taken into account.

A minimum of two screws shall be used for tensile reinforcement perpendicular to the grain. Only one screw may be used when the minimum penetration depth of the screws below and above the potential crack is  $20 \cdot d$  where  $d$  is the outer thread diameter of the screw.

#### Design

##### Connection forces at an angle to the grain

The axial capacity of a reinforcement of a timber member loaded by a connection force perpendicular to the grain shall fulfil the following condition:

$$\frac{[1 - 3 \cdot \alpha^2 + 2 \cdot \alpha^3] \cdot F_{90,d}}{F_{ax,Rd}} \leq 1$$

where

$F_{90,d}$  design value of the force component perpendicular to the grain,

$\alpha$  =  $a/h$

$a$  see Figure A.4.1

$h$  = member depth

$F_{ax,Rd} = \min \{ f_{ax,d} \cdot d \cdot \ell_{ef}; F_{t,Rd} \}$

$f_{ax,d}$  design value of the axial withdrawal capacity of the threaded part of the screw

$d$  outer thread diameter of the screw

$\ell_{ef}$  smaller value of the penetration depth below or above the potential crack,

$F_{t,Rd}$  design value of the tensile resistance of the screw =  $f_{tens,d}$

Outside the connection only one screw each in longitudinal direction of the beam shall be taken into account.



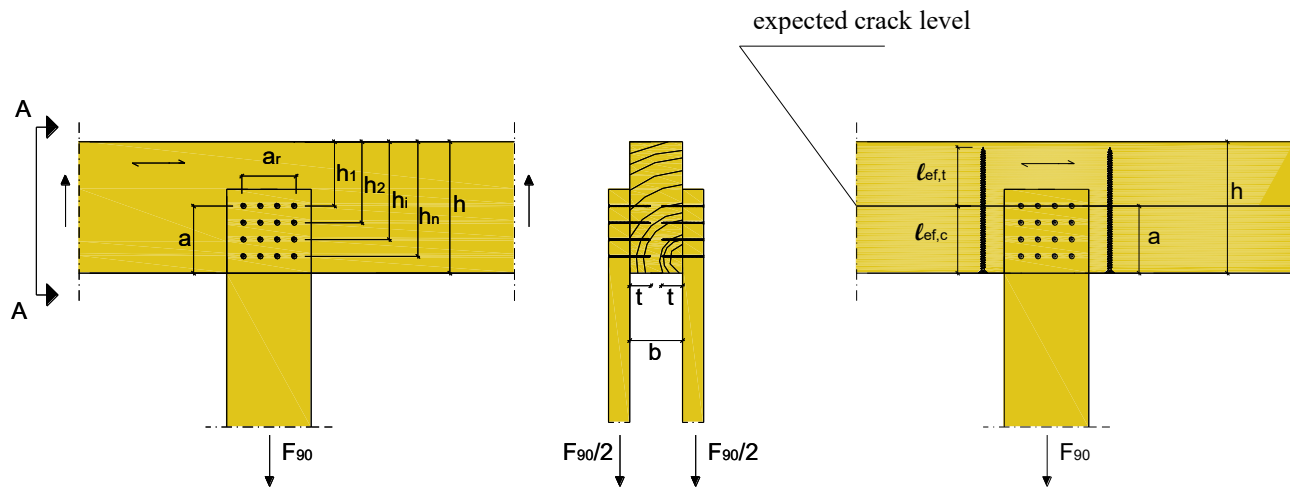

Figure 5: Example for tensile reinforcement of a connection force perpendicular to the grain

### Notched beam supports

The axial capacity of a reinforcement of a notched beam support shall fulfil the following condition:

$$\frac{1,3 \cdot V_d \cdot \left[ 3 \cdot (1-\alpha)^2 - 2 \cdot (1-\alpha)^3 \right]}{F_{ax,Rd}} \leq 1$$

where

$V_d$  design value of the shear force

$\alpha = h_e/h$

$h$  = member depth

$F_{ax,Rd} = \min \{ f_{ax,d} \cdot d \cdot l_{ef}; F_{t,Rd} \}$

$f_{ax,d}$  design value of the axial withdrawal capacity of the threaded part of the screw

$d$  outer thread diameter of the screw

$l_{ef}$  smaller value of the penetration depth below or above the potential crack, the total minimum penetration depth of the screw shall be  $2 \cdot l_{ef}$

$F_{t,Rd}$  design value of the tensile resistance of the screws =  $f_{tens,d}$

Only one screw in longitudinal direction of the beam shall be taken into account.

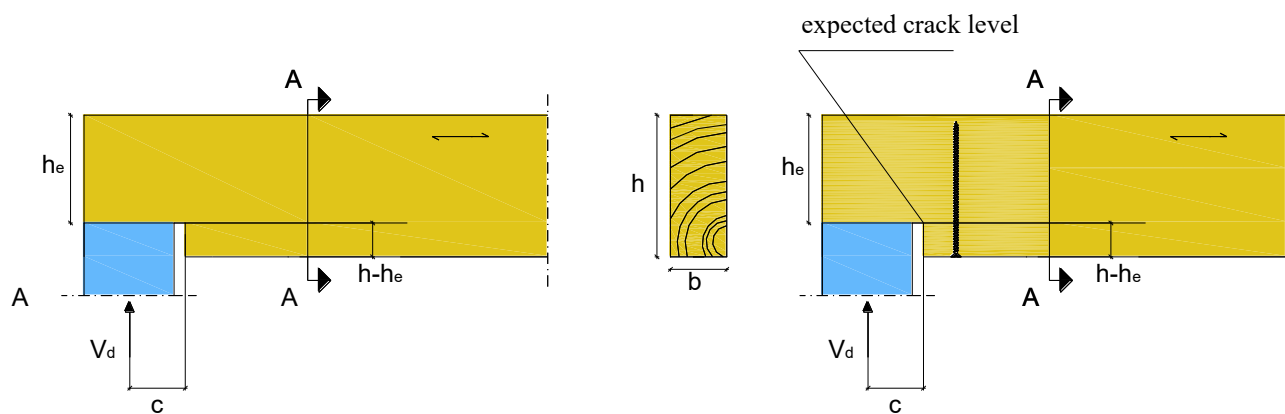

Figure 6: Example for tensile reinforcement of a notched beam support

## Annex F

### Fastening of thermal insulation material on top of rafters

#### General

HECO screws with an outer thread diameter of at least 6 mm may be used for the fixing of thermal insulation material on top of rafters or on wood-based members in vertical façades. In the following, the meaning of the word rafter includes wood-based members with inclinations between 0° and 90°.

The thickness of the thermal insulation material may be up to 400 mm. The thermal insulation material shall be applicable as insulation on top of rafters or on façades according to national provisions that apply at the installation site.

The battens have to be from solid timber (softwood) according to EN 338/ EN 14081-1. The minimum thickness  $t$  and the minimum width  $b$  of the battens are given in table 6:

Table 6: Minimum thickness and minimum width of the battens

Outer thread diameter [mm]	Minimum thickness $t$ [mm]	Minimum width $b$ [mm]
6 and 8	30	50
10	40	60

The minimum width of the rafters is 60 mm.

A reduced unloaded edge distance  $a_{4,c}$  of 2.5  $d$  of axially loaded screws in rafters may be used under the following conditions:

- Characteristic density of the rafter:  $\rho_k \leq 460 \text{ kg/m}^3$
- Outer thread diameter of the screw:  $6 \text{ mm} \leq d \leq 8 \text{ mm}$
- Depth  $h$  of the rafter parallel to screw axis:  $h \geq 16 d$
- Width  $b$  of the rafter perpendicular to screw axis:  $b \geq 5 d$
- Loaded or unloaded end distance:  $a_{3,t/c} \geq 25 d$
- Spacing parallel to the grain:  $a_1 \geq 25 d$

Friction forces shall not be considered for the design of the characteristic axial load of the screws.

The anchorage of wind suction forces as well as the bending stresses of the battens shall be considered for design. Screws perpendicular to the grain of the rafter (angle  $\alpha = 90^\circ$ ) may be arranged where required considering the design of the battens.

#### Parallel inclined screws and thermal insulation material in compression

##### Mechanical model

The system of rafter, thermal insulation material on top of rafter and battens parallel to the rafter may be considered as a beam on elastic foundation. The batten represents the beam, and the thermal insulation material on top of the rafter the elastic foundation. The minimum compression stress of the thermal insulation material at 10 % deformation, measured according to EN 8261, shall be  $\sigma_{(10\%)} = 0,05 \text{ N/mm}^2$ . The batten is loaded perpendicular to the axis by point loads  $F_b$ . Further point loads  $F_s$  are from the shear load of the roof due to dead and snow load, which are transferred from the thread under the screw head or from the screw head into the battens.

Only HECO-TOPIX-plus and HECO-TOPIX-T screws shall be used in this system.

Instead of battens the following wood-based panels may be used to cover the thermal insulation material if they are suitable for that use:

- Plywood according to EN 636 and EN 13986,
- Oriented Strand Board, OSB according to EN 300 and EN 13986,
- Particleboard according to EN 312 and EN 13986
- Fibreboards according to EN 622-2, EN 622-3 and EN 13986.

Only screws with countersunk head and raised countersunk head shall be used for fixing wood-based panels on rafters with thermal insulation material as interlayer.

The minimum thickness of the wood-based panels shall be 22 mm.

The word batten includes the meaning of wood-based panels in the following.

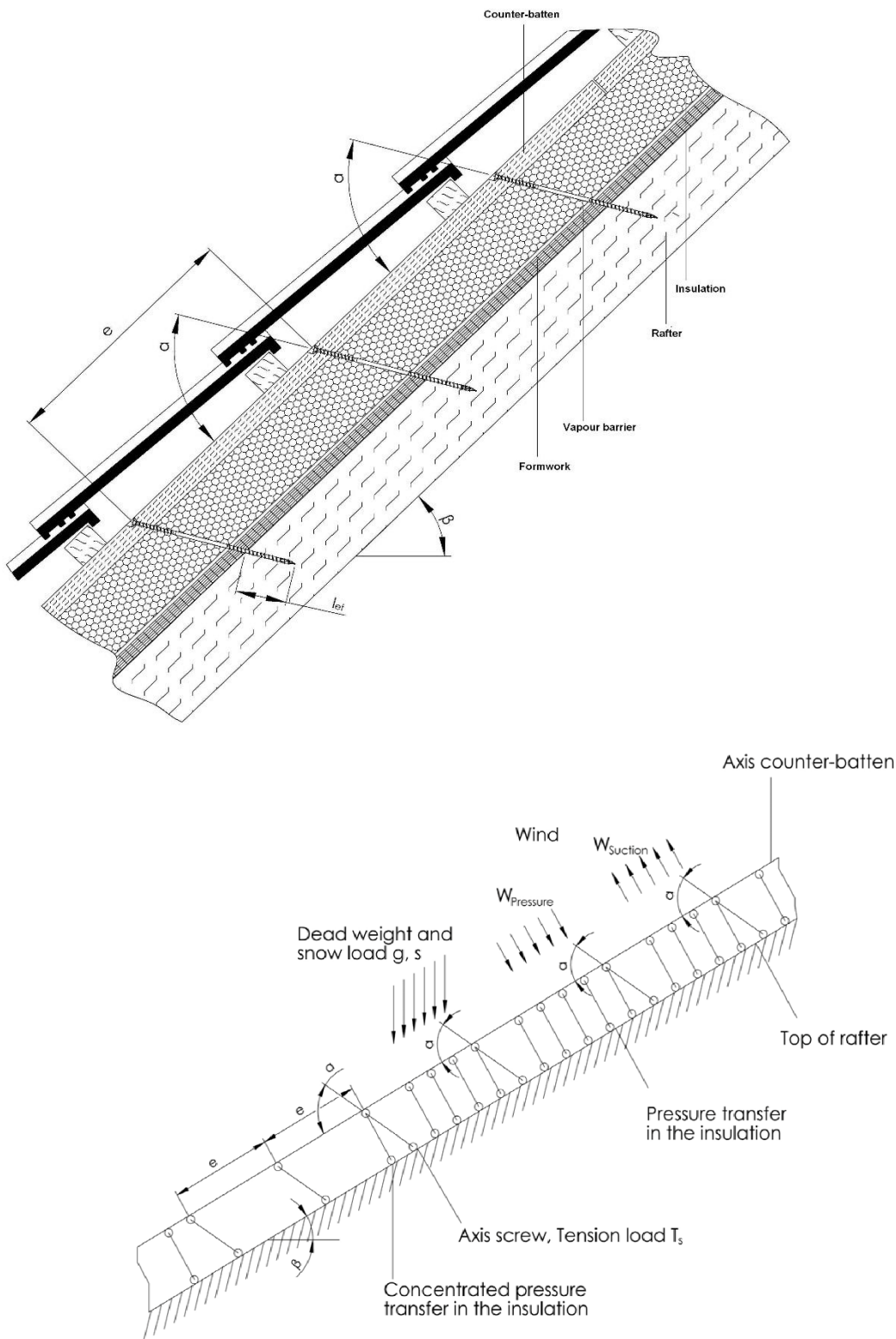

Figure 7: Fastening of the thermal insulation material on top of rafters - structural system for parallel inclined screws

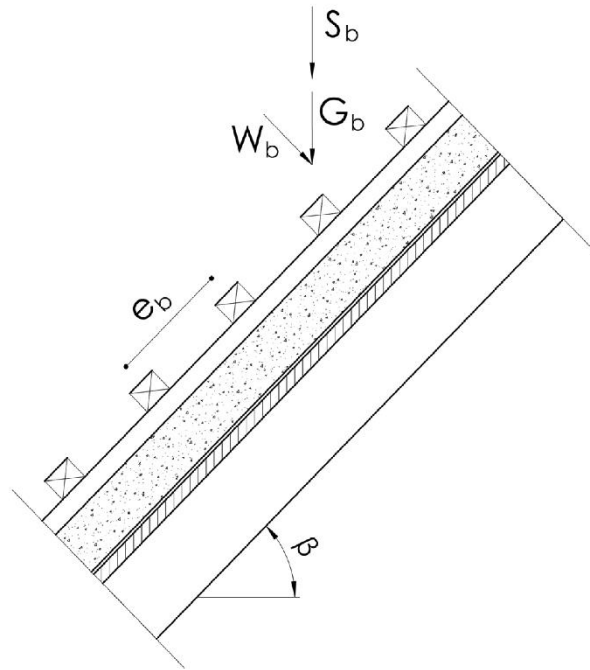

Figure 8: Point loads  $F_b$  perpendicular to the battens

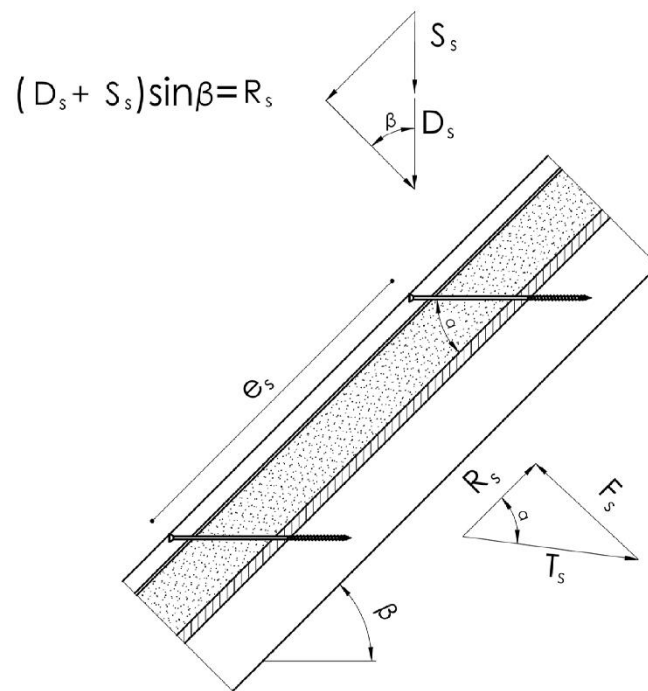

Figure 9: Point loads  $F_s$  perpendicular to the battens, load application in the area of the screw heads

## Design of the battens

The characteristic values of the bending stresses are calculated as:

$$M_k = \frac{(F_{b,k} + F_{s,k}) \cdot l_{\text{char}}}{4}$$

where

$$l_{\text{char}} = \text{Characteristic length } l_{\text{char}} = \sqrt[4]{\frac{4 \cdot EI}{w_{\text{ef}} \cdot K}}$$

EI = Bending stiffness of the batten

K = modulus of subgrade reaction

$w_{\text{ef}}$  = Effective width of the thermal insulation material

$F_{b,k}$  = Characteristic value of the point loads perpendicular to the battens

$F_{s,k}$  = Characteristic value of the point loads perpendicular to the battens, load application in the area of the screw heads

The modulus of subgrade reaction K may be calculated from the modulus of elasticity  $E_{\text{HI}}$  and the thickness  $t_{\text{HI}}$  of the thermal insulation material if the effective width  $w_{\text{ef}}$  of the thermal insulation material under compression is known. Due to the load extension in the thermal insulation material the effective width  $w_{\text{ef}}$  is greater than the width of the batten or rafter, respectively. For further calculations, the effective width  $w_{\text{ef}}$  of the thermal insulation material may be determined according to:

$$w_{\text{ef}} = w + t_{\text{HI}} / 2$$

where

w = Minimum from width of the batten or rafter, respectively

$t_{\text{HI}}$  = Thickness of the thermal insulation material

$$K = \frac{E_{\text{HI}}}{t_{\text{HI}}}$$

The following condition shall be satisfied:

$$\frac{\sigma_{m,d}}{f_{m,d}} = \frac{M_d}{W \cdot f_{m,d}} \leq 1$$

For the calculation of the section modulus W the net cross section shall be considered.

The characteristic value of the shear stresses shall be calculated according to:

$$V_k = \frac{(F_{b,k} + F_{s,k})}{2}$$

The following condition need to be satisfied:

$$\frac{\tau_d}{f_{v,d}} = \frac{1.5 \cdot V_d}{A \cdot f_{v,d}} \leq 1$$

For the calculation of the cross section area the net cross section shall be considered.

### A.5.2.3 Design of the thermal insulation material

The characteristic value of the compressive stresses in the thermal insulation material shall be calculated according to:

$$\sigma_k = \frac{1.5 \cdot F_{b,k} + F_{s,k}}{2 \cdot l_{\text{char}} \cdot w}$$

The design value of the compressive stress shall not be greater than 110 % of the compressive stress at 10 % deformation calculated according to EN 826.

### Design of the screws

The screws are loaded predominantly axially. The characteristic value of the axial tension force in the screw may be calculated from the shear loads of the roof  $R_s$ :

$$T_{S,k} = \frac{R_{S,k}}{\cos \alpha}$$

The load-carrying capacity of axially loaded screws is the minimum design value of the axial withdrawal capacity of the threaded part of the screw, the head pull-through capacity of the screw and the tensile capacity of the screw according to section 3.9.

In order to limit the deformation of the screw head for thermal insulation material with thickness over 220 mm or with compressive stress  $\sigma_{(10\%)}$  below 0.12 N/mm<sup>2</sup>, respectively, the axial withdrawal capacity of the screws shall be reduced by the factors  $k_1$  and  $k_2$ .

In the case that wood-based panels cover the thermal insulation material:

$$F_{ax,\alpha,Rd} = \min \left\{ k_{ax} \cdot f_{ax,90,d} \cdot d \cdot l_{ef,r} \cdot k_1 \cdot k_2 \cdot \left( \frac{\rho_k}{350} \right)^{0.8}; f_{head,d} \cdot d_h^2 \cdot \left( \frac{\rho_k}{350} \right)^{0.8}; \frac{f_{tens,k}}{\gamma_{M2}} \right\}$$

In the case that battens cover the thermal insulation material:

$$F_{ax,\alpha,Rd} = \min \left\{ \begin{array}{l} k_{ax} \cdot f_{ax,90,d} \cdot d \cdot l_{ef,r} \cdot k_1 \cdot k_2 \cdot \left( \frac{\rho_k}{350} \right)^{0.8} \\ f_{head,d} \cdot d_h^2 \cdot \left( \frac{\rho_k}{350} \right)^{0.8} \\ k_{ax} \cdot f_{ax,90,d} \cdot d \cdot l_{ef,b} \cdot \left( \frac{\rho_k}{350} \right)^{0.8} \\ \frac{f_{tens,k}}{\gamma_{M2}} \end{array} \right.$$

where:

$k_{ax}$	Factor, taking into account the angle $\alpha$ between screw axis and grain direction according to section Axial withdrawal capacity
$f_{ax,90,d}$	design value of the axial withdrawal parameter of the threaded part of the screw perpendicular to the grain [N/mm <sup>2</sup> ]
$d$	outer thread diameter of the screw [mm]
$l_{ef,r}$	penetration length of the threaded part of the screw in the rafter, $l_{ef} \geq 40$ mm
$l_{ef,b}$	penetration length of the threaded part of the screw in the batten [mm]
$\rho_k$	characteristic density of the wood-based member [kg/m <sup>3</sup> ], for softwood LVL $\rho_k \leq 500$ kg/m <sup>3</sup> , for ash, beech and oak $\rho_k \leq 590$ kg/m <sup>3</sup>
$\alpha$	angle $\alpha$ between screw axis and grain direction, $30^\circ \leq \alpha \leq 90^\circ$
$f_{head,d}$	design value of the head pull-through parameter of the screw [N/mm <sup>2</sup> ]
$d_h$	head diameter [mm]
$f_{tens,k}$	characteristic tensile capacity of the screw according to annex 2 [N]
$\gamma_{M2}$	partial factor according to EN 1993-1-1 in conjunction with the particular national annex
$k_1$	$\min \{1; 220/t_{HI}\}$
$k_2$	$\min \{1; \sigma_{10\%}/0,12\}$
$t_{HI}$	thickness of the thermal insulation material [mm]
$\sigma_{10\%}$	compressive stress of the thermal insulation material under 10 % deformation [N/mm <sup>2</sup> ]

If one of the above mentioned equations is fulfilled, the deflection of the battens does not need to be considered when designing the load-carrying capacity of the screws.

## Alternatively inclined screws and thermal insulation material not in compression

### Mechanical model

Depending on the screw spacing and the arrangement of tensile and compressive screws with different inclinations the battens are loaded by significant bending moments. The bending moments are derived based on the following assumptions:

- The tensile and compressive loads in the screws are determined based on equilibrium conditions from the actions parallel and perpendicular to the roof plane. These actions are constant line loads  $q_{\perp}$  and  $q_{\parallel}$ .
- The screws act as hinged columns supported 10 mm within the batten or rafter, respectively. The effective column length consequently equals the length of the screw between batten and rafter plus 20 mm.
- The batten is considered as a continuous beam with a constant span  $\ell = A + B$ . The compressive screws constitute the supports of the continuous beam while the tensile screws transfer concentrated loads perpendicular to the batten axis.

The screws are predominantly loaded in withdrawal or compression, respectively. The characteristic values of the screw's normal forces are determined based on the loads parallel and perpendicular to the roof plane:

$$\text{Compressive screw: } N_{c,k} = e \cdot \left( -\frac{q_{\parallel,k}}{\cos \alpha_1 + \sin \alpha_1 / \tan \alpha_2} - \frac{q_{\perp,k} \cdot \sin(90^\circ - \alpha_2)}{\sin(\alpha_1 + \alpha_2)} \right)$$

$$\text{Tensile screw: } N_{t,k} = e \cdot \left( \frac{q_{\parallel,k}}{\cos \alpha_2 + \sin \alpha_2 / \tan \alpha_1} - \frac{q_{\perp,k} \cdot \sin(90^\circ - \alpha_1)}{\sin(\alpha_1 + \alpha_2)} \right)$$

$e$  distance of the perpendicular to the grain inserted screws according to Figure 5.4

$q_{\parallel,k}$  characteristic value of the loads parallel to the roof plane

$q_{\perp,k}$  characteristic value of the loads perpendicular to the roof plane

$\alpha$  Angle  $\alpha_1$  and  $\alpha_2$  between screw axis and grain direction,  $30^\circ \leq \alpha_1 \leq 90^\circ$ ,  $30^\circ \leq \alpha_2 \leq 90^\circ$

The bending moments in the batten follow from the constant line load  $q_{\perp}$  and the load components perpendicular to the batten from the tensile screws. The span of the continuous beam is  $(A + B)$ . The characteristic value of the load component perpendicular to the batten from the tensile screw is:

$$F_{ZS,k} = e \cdot \left( \frac{q_{\parallel,k}}{1 / \tan \alpha_1 + 1 / \tan \alpha_2} - \frac{q_{\perp,k} \cdot \sin(90^\circ - \alpha_1) \cdot \sin \alpha_2}{\sin(\alpha_1 + \alpha_2)} \right)$$

A positive value for  $F_{ZS,k}$  means a load towards the rafter, a negative value a load away from the rafter. The system of the continuous beam is shown in Figure 8.

The battens fixed on the rafter shall be supported perpendicular to the load-bearing plane.



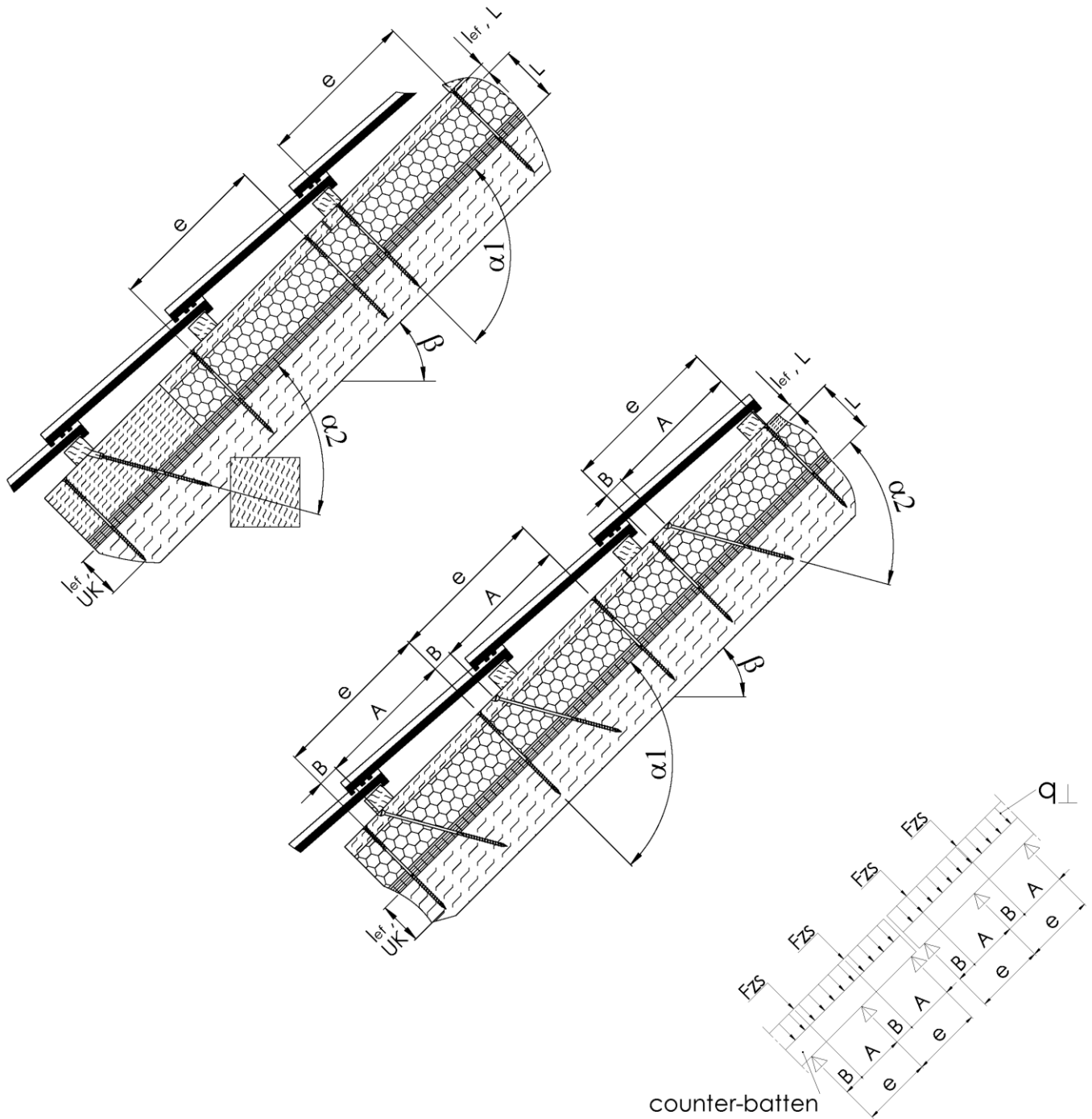

Figure 8 Fastening of thermal insulation material on top of rafters - structural system for alternatively inclined screws and continuous batten under constant line loads from actions on the roof plane  $q_{\perp}$  and concentrated loads from tensile screws  $F_{ZS}$

## Design of the screws

The design value of the load-carrying capacity of the screws shall be calculated according to equations “Compressive screw” and “Tensile screw” given in the section Mechanical model.

Screws loaded in tension:

$$F_{ax,\alpha,Rd} = \min \left\{ k_{ax} \cdot f_{ax,90,d} \cdot d \cdot l_{ef,b} \cdot \left( \frac{\rho_{b,k}}{350} \right)^{0.8} ; k_{ax} \cdot f_{ax,90,d} \cdot d \cdot l_{ef,r} \cdot \left( \frac{\rho_{r,k}}{350} \right)^{0.8} ; \frac{f_{tens,k}}{\gamma_{M2}} \right\}$$

Screws loaded in compression:

$$F_{ax,\alpha,Rd} = \min \left\{ k_{ax} \cdot f_{ax,90,d} \cdot d \cdot l_{ef,b} \cdot \left( \frac{\rho_{b,k}}{350} \right)^{0.8} ; k_{ax} \cdot f_{ax,90,d} \cdot d \cdot l_{ef,r} \cdot \left( \frac{\rho_{r,k}}{350} \right)^{0.8} ; \frac{\kappa_c \cdot N_{pl,k}}{\gamma_{M1}} \right\}$$

where:

$k_{ax}$	factor, taking into account the angle $\alpha$ between screw axis and grain direction according to section Axial withdrawal capacity
$f_{ax,90,d}$	design value of the axial withdrawal parameter of the threaded part of the screw perpendicular to the grain in the batten [N/mm <sup>2</sup> ]
$d$	outer thread diameter of the screw [mm]
$l_{ef,b}$	penetration length of the threaded part of the screw in the batten [mm]
$l_{ef,r}$	penetration length of the threaded part of the screw in the rafter, $l_{ef} \geq 40$ mm
$\rho_{b,k}$	characteristic density of the batten [kg/m <sup>3</sup> ], for softwood LVL $\rho_k \leq 500$ kg/m <sup>3</sup> , for ash, beech and oak $\rho_k \leq 590$ kg/m <sup>3</sup>
$\rho_{r,k}$	characteristic density of the rafter [kg/m <sup>3</sup> ], for softwood LVL $\rho_k \leq 500$ kg/m <sup>3</sup> , for ash, beech and oak $\rho_k \leq 590$ kg/m <sup>3</sup>
$\alpha$	angle $\alpha_1$ or $\alpha_2$ between screw axis and grain direction, $30^\circ \leq \alpha_1 \leq 90^\circ$ , $30^\circ \leq \alpha_2 \leq 90^\circ$
$f_{tens,k}$	characteristic tensile capacity of the screw according to section 3.1 [N]
$\gamma_{M1}, \gamma_{M2}$	partial factor according to EN 1993-1-1 in conjunction with the particular national annex
$\kappa_c \cdot N_{pl,k}$	buckling capacity of the screw according to table 7 [N]

Table 7 Characteristic buckling capacity of the screws  $\kappa_c \cdot N_{pl,k}$  in kN

Free screw length L of the screws between batten and rafter [mm]	HECO-TOPIX-plus-CC		HECO-TOPIX-plus-T		Fully threaded HECO-TOPIX-plus screws			HECO-TOPIX-plus-T		
	Carbon steel							Stainless steel		
	Outer thread diameter d [mm]									
	6.0	8.0	8.0	10.0	6.0	8.0	10.0	8.0	10.0	
	$\kappa_c \cdot N_{pl,k}$ [kN]									
≤ 100	1.11	3.73	6.37	11.70	1.11	3.73	8.07	5.69	10.1	
120	0.84	2.85	4.92	9.22	0.84	2.85	6.27	4.51	8.20	
140	0.66	2.25	3.90	7.38	0.66	2.25	4.99	3.64	6.73	
160	0.53	1.81	3.16	6.03	0.53	1.81	4.05	2.98	5.59	
180	0.43	1.50	2.61	5.00	0.43	1.50	3.35	2.48	4.69	
200	0.36	1.25	2.20	4.22	0.36	1.25	2.82	2.10	3.99	
220	0.30	1.06	1.87	3.60	0.30	1.06	2.41	1.79	3.42	
240	0.26	0.91	1.61	3.12	0.26	0.91	2.08	1.55	2.97	
260	0.23	0.79	1.40	2.72	0.23	0.79	1.81	1.36	2.60	
280	0.20	0.70	1.23	2.39	0.20	0.70	1.59	1.19	2.29	
300	0.17	0.61	1.09	2.11	0.17	0.61	1.40	1.06	2.04	
320	0.16	0.55	0.97	1.88	0.16	0.55	1.25	0.94	1.83	
340	0.14	0.49	0.87	1.69	0.14	0.49	1.12	0.85	1.64	
360	0.12	0.44	0.78	1.53	0.12	0.44	1.01	0.76	1.49	
380	0.11	0.40	0.71	1.38	0.11	0.40	0.92	0.69	1.35	
400	0.10	0.36	0.65	1.26	0.10	0.36	0.83	0.63	1.23	



**HECO-Schrauben GmbH & Co.KG**

Dr.-Kurt-Stein-Straße 28 · D-78713 Schramberg

Tel.: +49 (0) 74 22 / 9 89-0 · Fax: +49 (0) 74 22 / 9 89-200

Mail: [info@heco-schrauben.de](mailto:info@heco-schrauben.de) · [www.heco-schrauben.de](http://www.heco-schrauben.de)